

MUZIKZAK

KLAVER

12 tangenter

E-bog

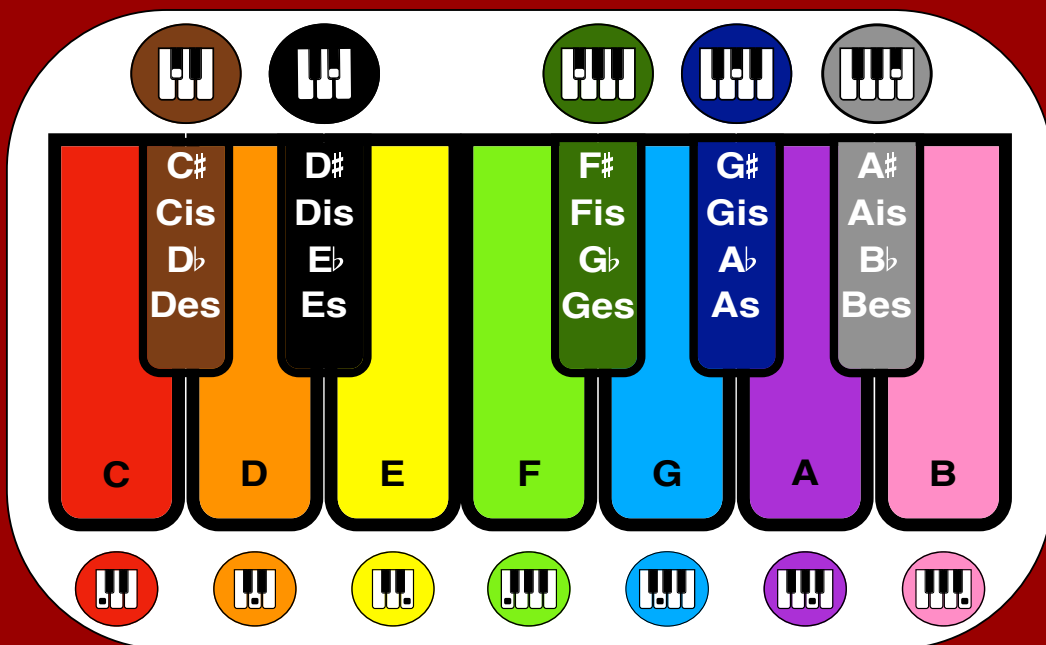

Elevbog

Af Toke Scharbau Stryhn

www.musikogrytmik.dk

Muzikzak, Klaver - 12 tangenter - Elevbog - E-bog

Af: Toke Scharbau Stryhn

Andre titler af Toke Scharbau Stryhn:

Muzikzak, Klaver - 12 tangenter - Lærervejledning

Muzikzak, Rytmer - *Da, didi, ssh og digedige* - Elevbog

Muzikzak, Rytmer - *Da, didi, ssh og digedige* - Lærervejledning

Muzikzak, Solfa - 7 håndtegn og solfadyr - Elevbog

Muzikzak, Solfa - 7 håndtegn og solfadyr - Lærervejledning

Musik og rytmik - for dig og mig - Sangbog

Forlag: Forlaget Musik og Rytmik

www.musikogrytmik.dk

www.facebook.com/musikogrytmik

www.instagram.com/musikogrytmik

Copyright © 2023

MU**ZIK**ZAK

Klaver

12 tangenter

Elevbog

E-bog

Denne bog er beskyttet i medfør af gældende dansk lov om ophavsret. Kopiering må kun ske i overensstemmelse med loven. Det betyder f.eks. at kopiering til undervisningsbrug kun må ske efter aftale med Copydan Tekst og Node.

Af Toke Scharbau Stryhn

www.musikogrytmik.dk

Forord

Om Muzikzak

Muzikzak er en serie af intuitive undervisningsmaterialer, der har til formål at formidle viden om instrumenter og musikteori for bedre at kunne deltage i musikfælleskaber som fx kor og sammenspil. Materialerne er primært tænkt som et supplement til praktisk musikundervisning i grundskolen og på musikskoler. Elevbøgernes tilhørende lærervejledninger kommer med forslag til, hvordan læreren sideløbende kan supplere Muzikzak-bøgerne med teoretisk gennemgang af indholdet samt quizzer, musikaktiviteter, spil og i sammenspil.

Målet med bogen "*Muzikzak Klaver - 12 tangenter*" er at understøtte indlæringen af tonenavnene på klaverets tangenter for at give bedre forudsætninger for spil på klaver. Ydermere giver bogen et godt grundlag for videre arbejde med musikteori.

Om bogens indhold og opbygning

For at gøre bogen overskuelig er alle opgaverne opbygget ens med to opgaver pr. side. Det er i alle opgaver markeret med rødt, hvad eleven skal gøre for at løse opgaven. Man behøver derfor ikke kunne læse sikkert for at kunne arbejde selvstændigt med materialet.

For at gøre bogen så intuitiv som muligt, indeholder bogen opgavetyper, som de fleste kender fra andre undervisningsammenhænge: Labyrinter, skriv efter-opgaver, tælleopgaver, farveopgaver samt opgaver, hvor man skal sætte streger, prikker eller ringe. Som ekstraopgaver er der en række Sudoku-opgaver, som for nogen imidlertid kræver kort introduktion. Alle løsninger samt forslag til relevante musikaktiviteter og sange kan findes i den tilhørende lærervejledning.

Bogen er delt i to hovedafsnit med henholdsvis de 7 hvide tangenter og de 5 sorte tangenter. For ikke at glemme de toner, som allerede er lært, indgår alle de toner, som er lært tidligere i bogen, i mange af opgaverne.

For bedre at kunne orientere sig på klaviaturet og dermed hurtigere finde tonerne starter 1. del med opgaver om to grupper af toner. Den lille gruppe med tre hvide og to sorte tangenter og den store gruppe med fire hvide og tre sorte tangenter. Først uden tonenavne og herefter med tonenavne på de hvide tangenter: c, d, og e i den lille gruppe og f, g, a og b i den store gruppe. Herefter følger alle enkelttonerne en ad gangen, startende med c, d og e fra den lille gruppe og herefter f, g, a og b fra den store gruppe. Sidst i 1. del er der mere fokus på at finde flere toner i hhv. en oktav og flere oktaver. 1. del afsluttes med Sudoku-ekstraopgaver.

2. del om de sorte tangenter er opbygget ligesom 1. del og introducerer en tone ad gangen. Først tonerne fra den lille gruppe: Cis/Des og Dis/Es og dernæst tonerne fra den store gruppe: Fis, Gis og Ais. Til hver tone læres dog fire notationsmåder. Fx læres notationen af tonen Cis også som C#, Des og Db. De hvide tangenter er med som repetition i mange af opgaverne. 2. del afsluttes ligesom 1. del med Sudoku-opgaver som ekstraopgaver.

Om tonen *b*

Af pædagogiske hensyn anvendes tonenavnene: *b* og *bes* i stedet for *h* og *b*. Det anbefales dog, at man i musikundervisningen snakker om, at tonerne mange steder også kaldes henholdsvis *h* og *b*.

Bøgerne kan fås på hjemmesiden: www.musikogrytmik.dk

Klaver

1. del

De 7 hvide tangenter

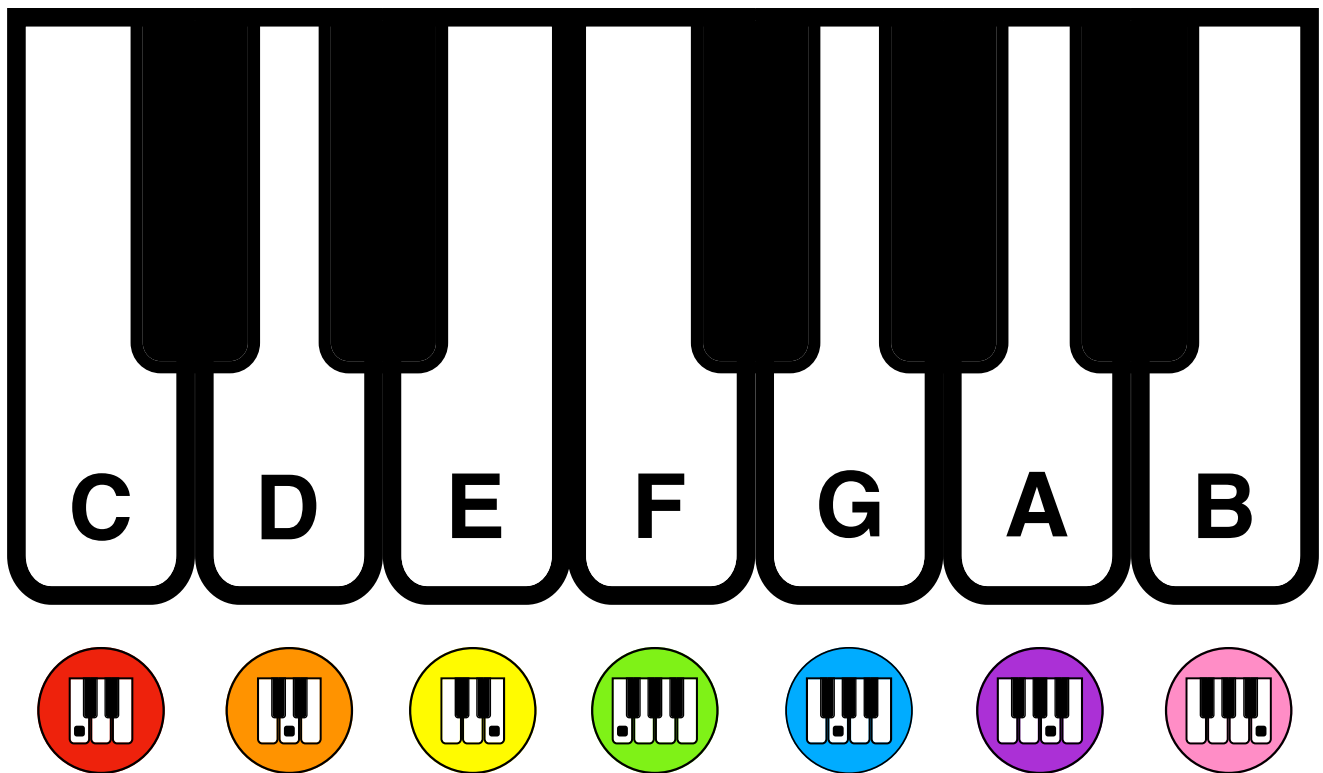

TEGN EFTER

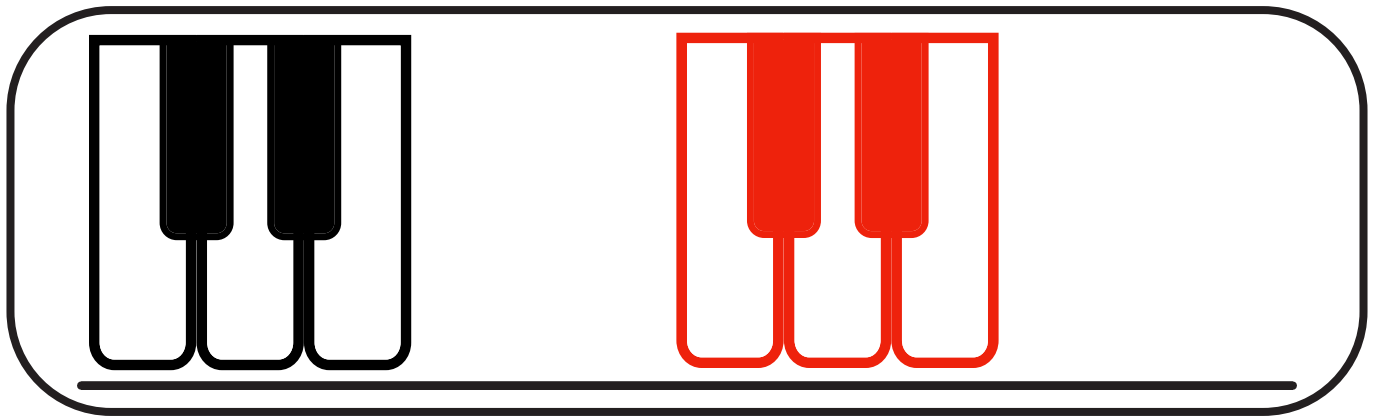

SÆT PRIKKER

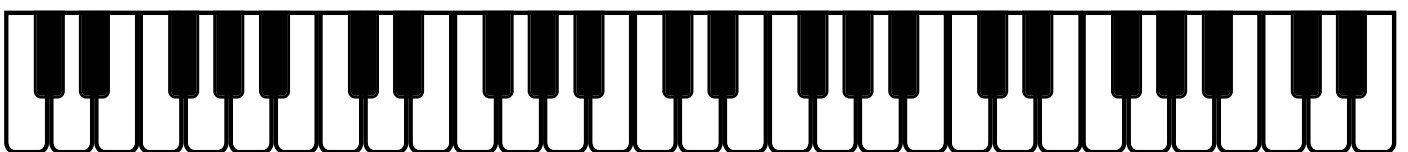
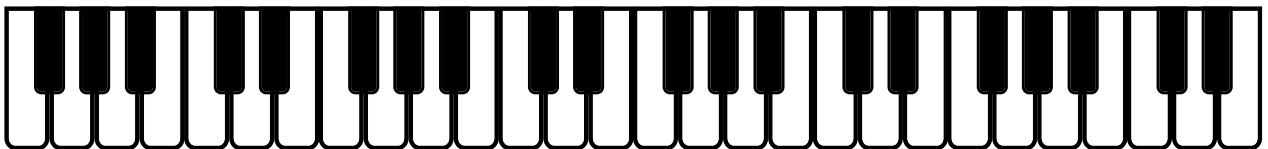
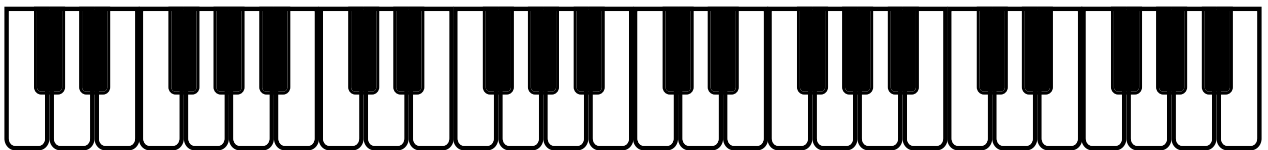
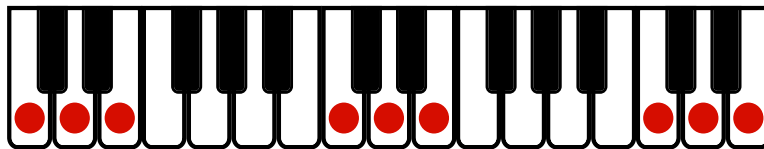

Kopiering til undervisningsbrug må kun ske efter aftale med Copydan Tekst og Node.

TEGN EFTER

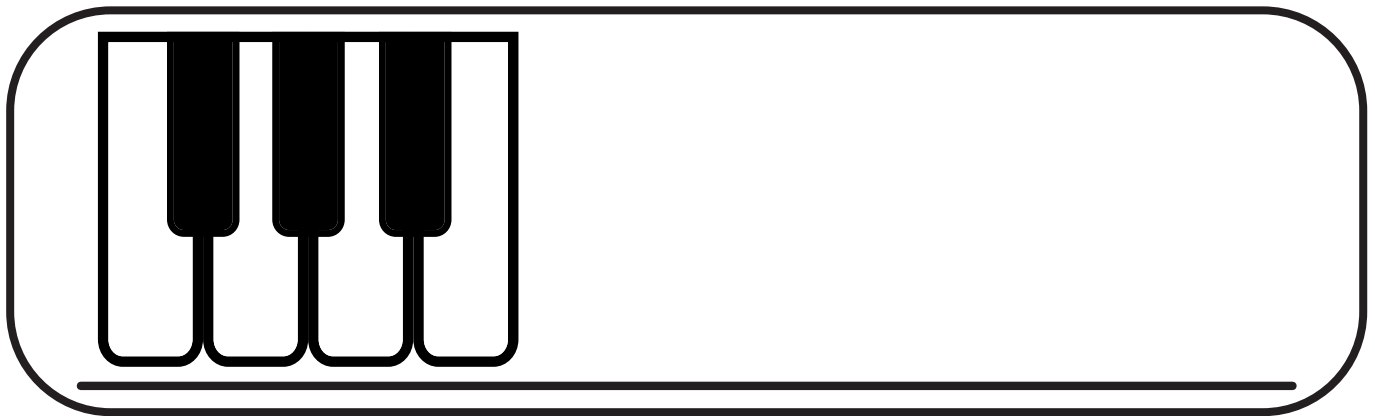
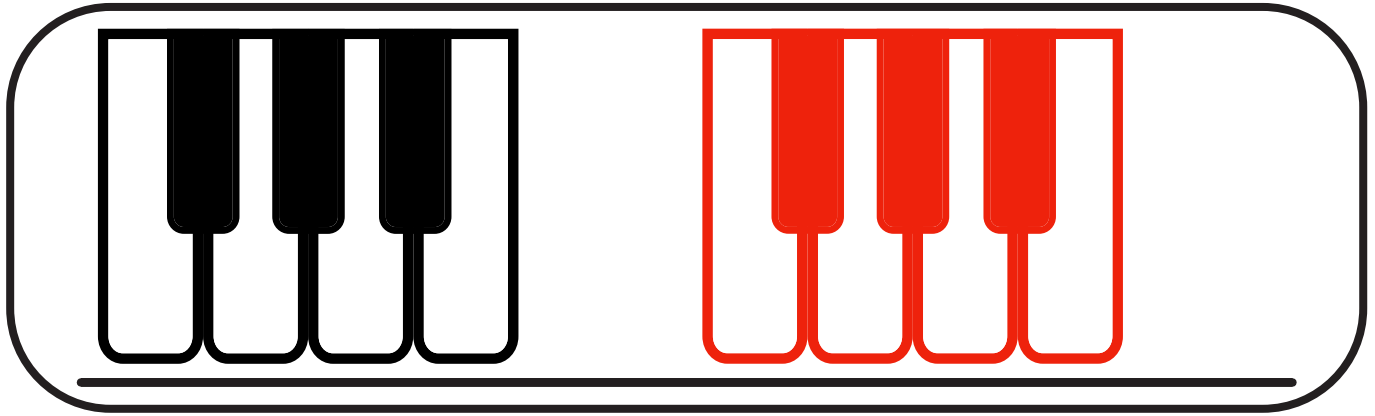

SÆT PRIKKER

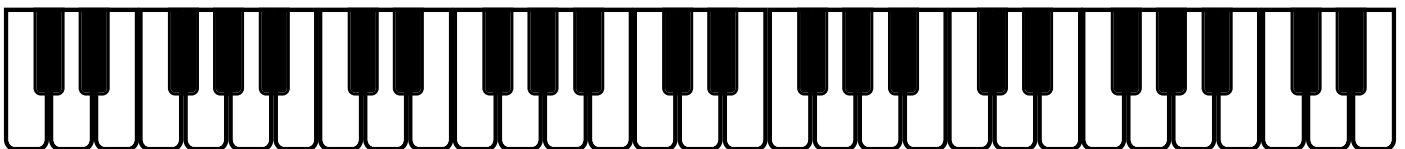
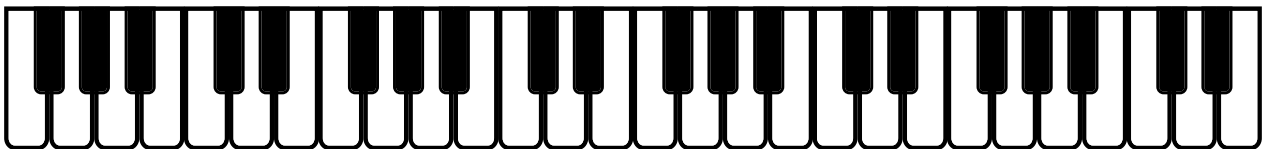
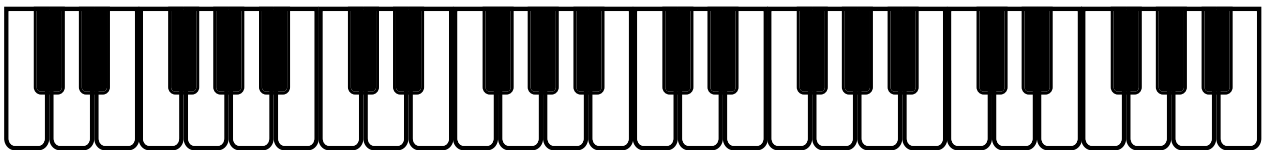
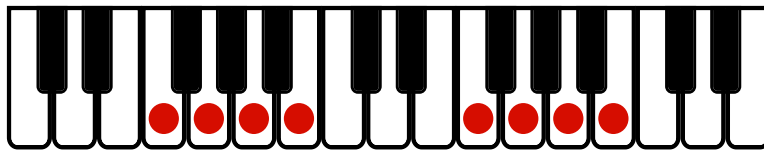

Kopiering til undervisningsbrug må kun ske efter aftale med Copydan Tekst og Node.

SÆT RINGE

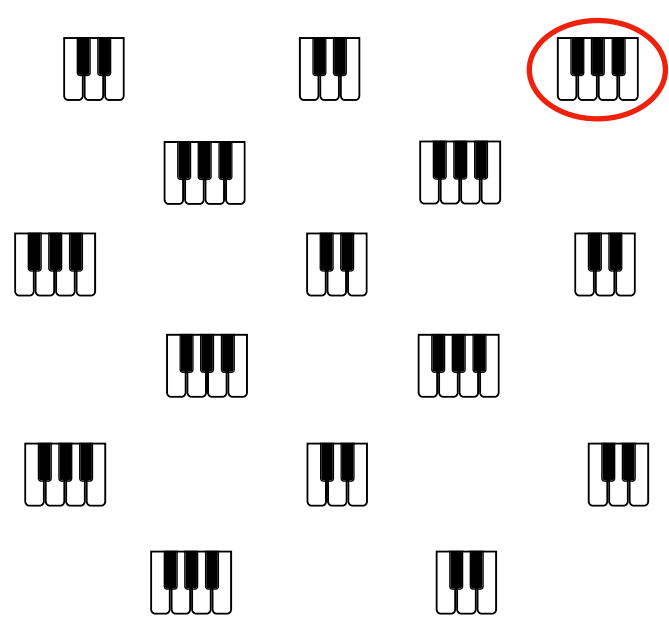
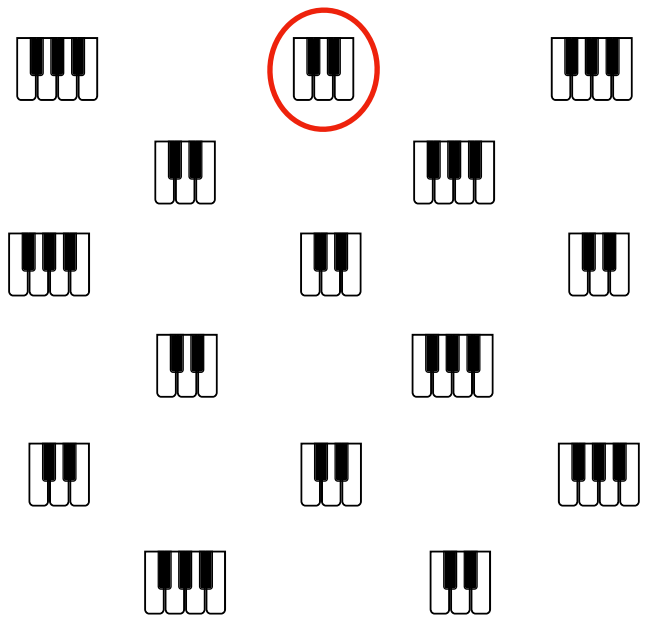
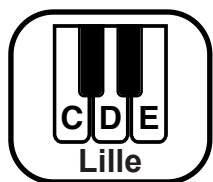

SÆT STREGER

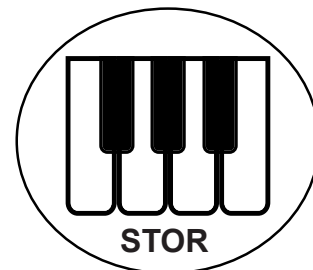
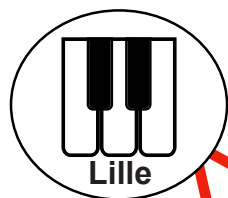

Kopiering til undervisningsbrug må kun ske efter aftale med Copydan Tekst og Node.

SÆT STREGER

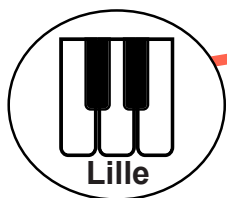

C D E

F G A B

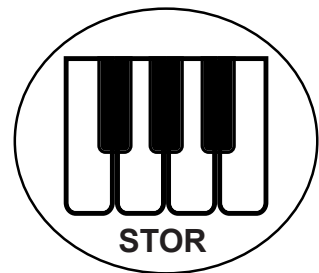

F G A B

C D E

C D E

C D E

F G A B

C D E

F G A B

C D E

C D E

F G A B

C D E

C D E

SÆT STREGER

C D E

F G A B

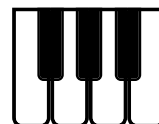
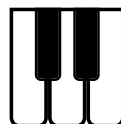
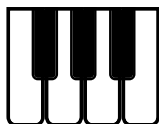
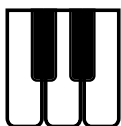
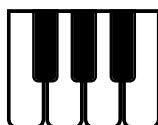
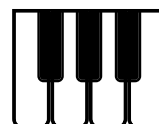
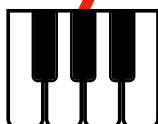
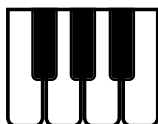
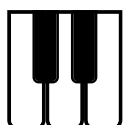
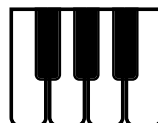
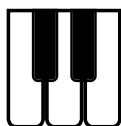
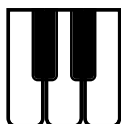
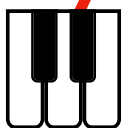

Kopiering til undervisningsbrug må kun ske efter aftale med Copydan Tekst og Node.

SÆT RINGE

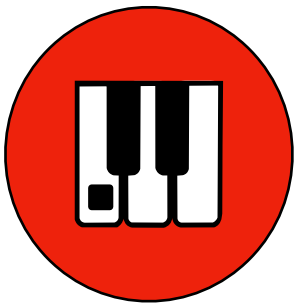

C

FIND VEJ



Kopiering til undervisningsbrug må kun ske efter aftale med Copydan Tekst og Node.

TÆL

13

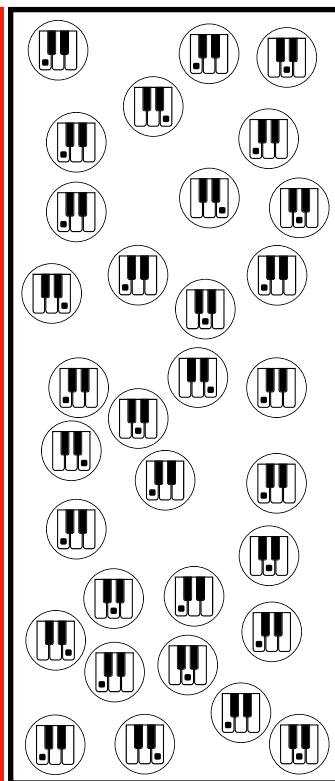
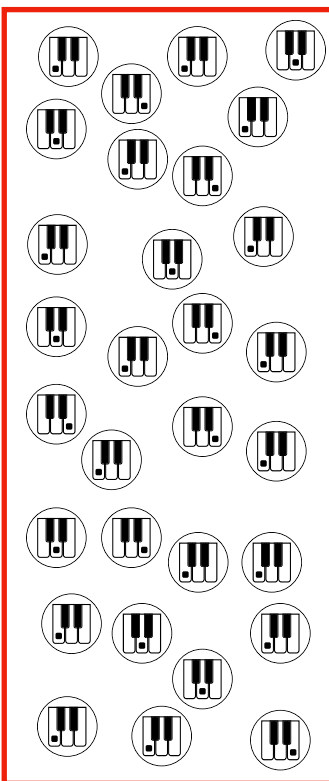
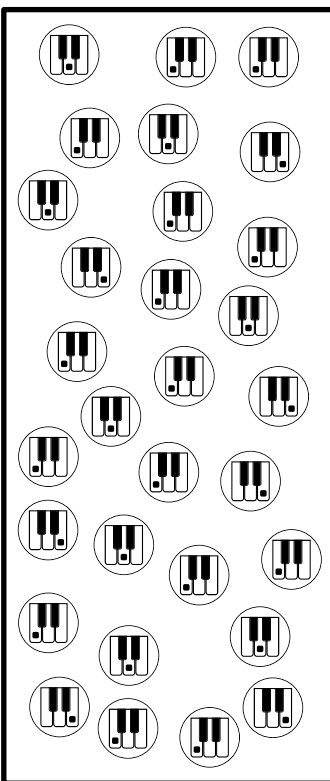
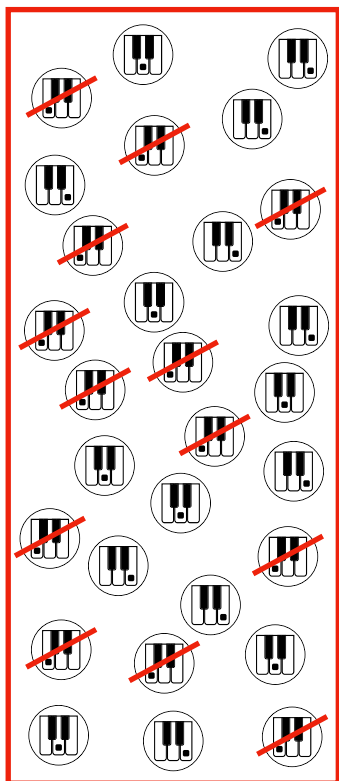

SÆT PRIKKER VED C

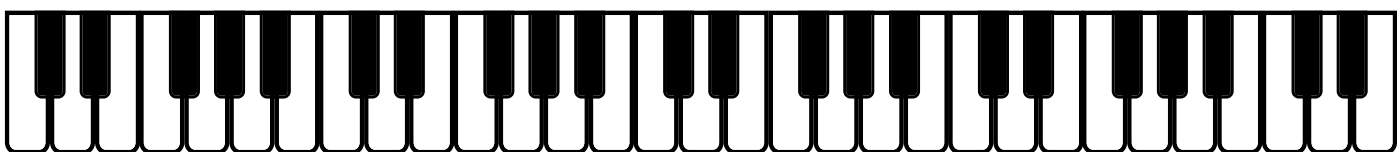
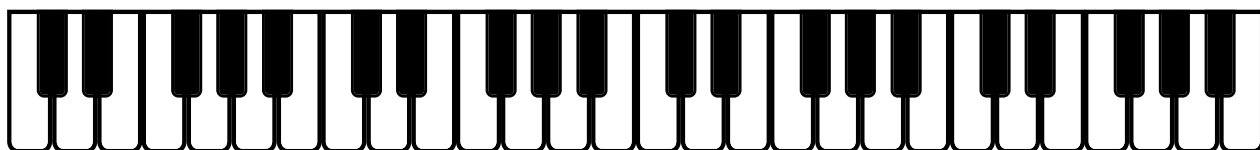
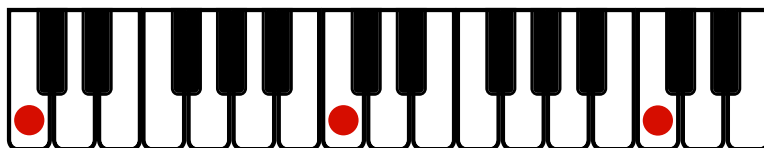

Kopiering til undervisningsbrug må kun ske efter aftale med Copydan Tekst og Node.

SÆT RINGE

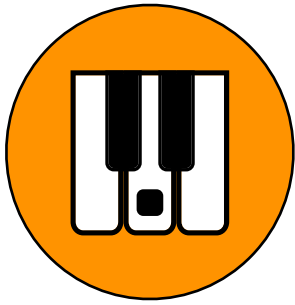

D

FIND VEJ

Kopiering til undervisningsbrug må kun ske efter aftale med Copydan Tekst og Node.

FARV

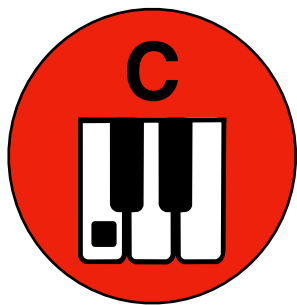

C	D			D		D	
D		D	D			C	
	D				C	D	
		D	C				
D			C		D		
	D				C		D
		D	D		D		
C				D		D	

SÆT STREGER

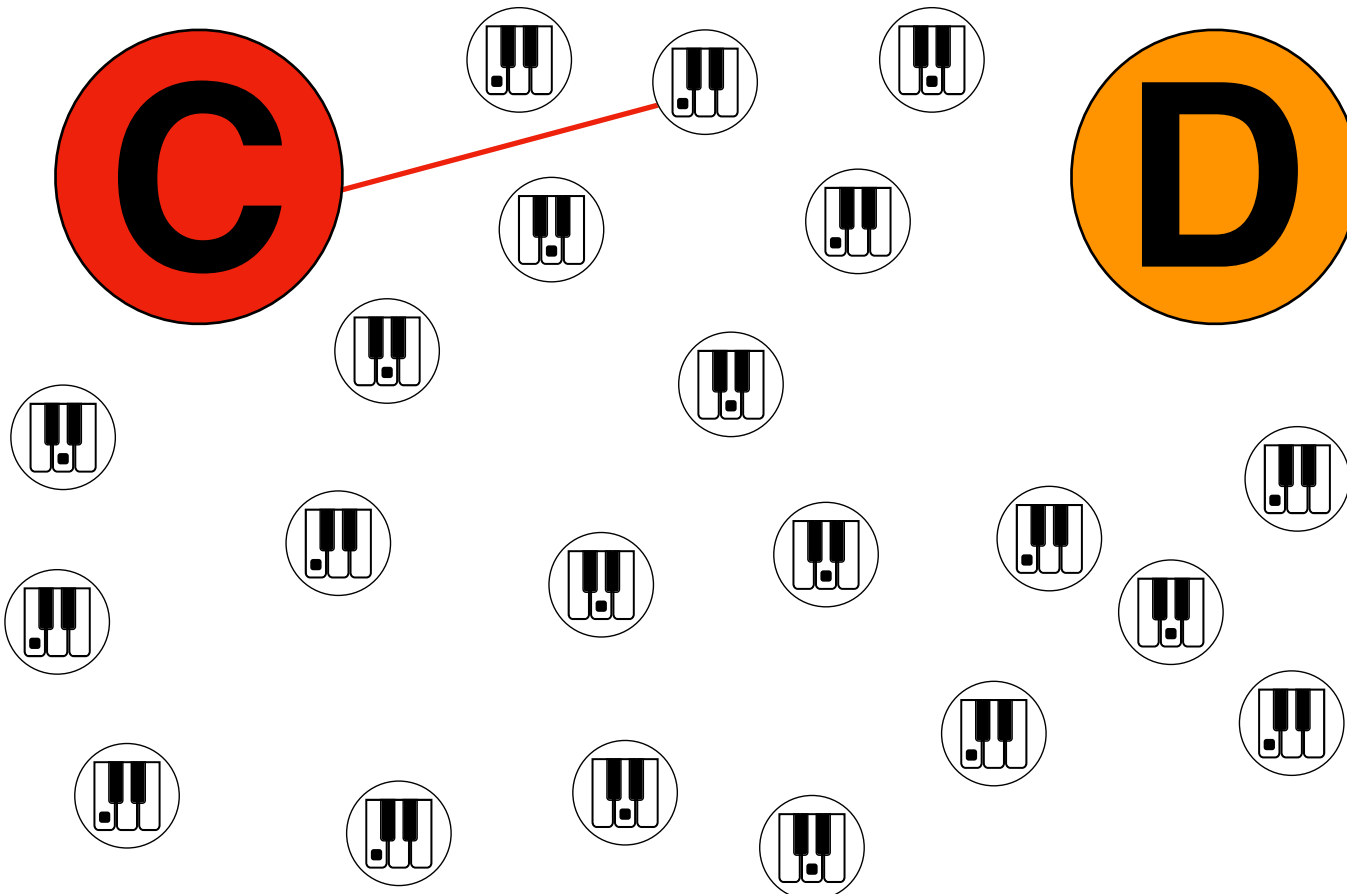
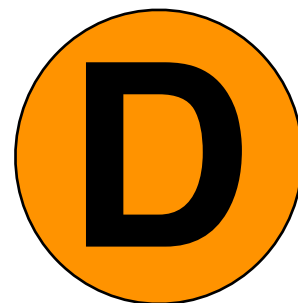
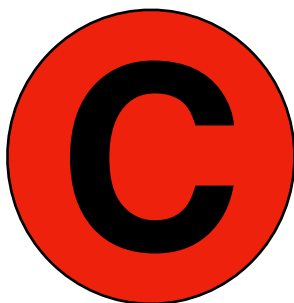

Kopiering til undervisningsbrug må kun ske efter aftale med Copydan Tekst og Node.

SÆT STREGER

This exercise consists of two columns of piano keyboard diagrams. The left column has six diagrams, and the right column has six diagrams. A red line connects the first diagram in the left column to the 'C D' key in the second column. The keys in the second column are: (D, C), (D), (C, D), (C, C), (D, D), and (C). The keys in the third column are: (C, C), (C, D), (D, C), (D), (C), and (D, D).

SÆT PRIKKER VED D

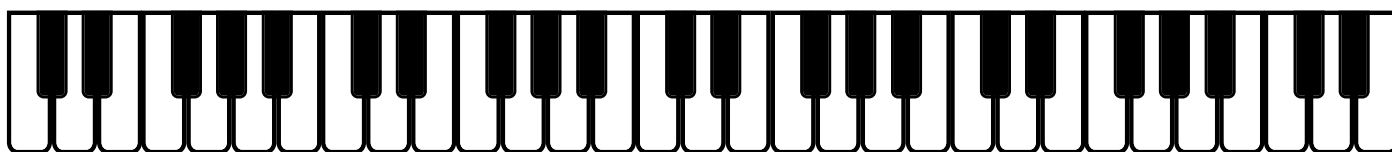
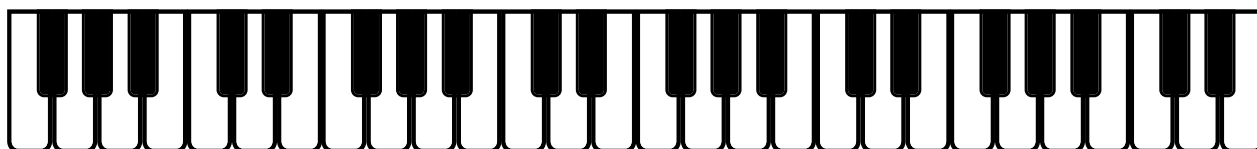
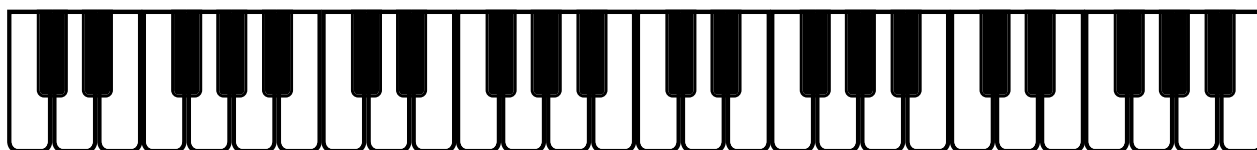

Kopiering til undervisningsbrug må kun ske efter aftale med Copydan Tekst og Node.

SÆT RINGE

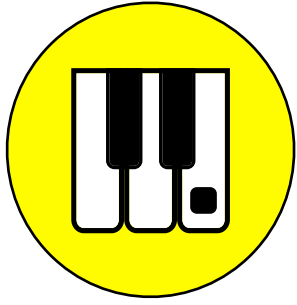

E

FIND VEJ



Kopiering til undervisningsbrug må kun ske efter aftale med Copydan Tekst og Node.

SÆT RINGE

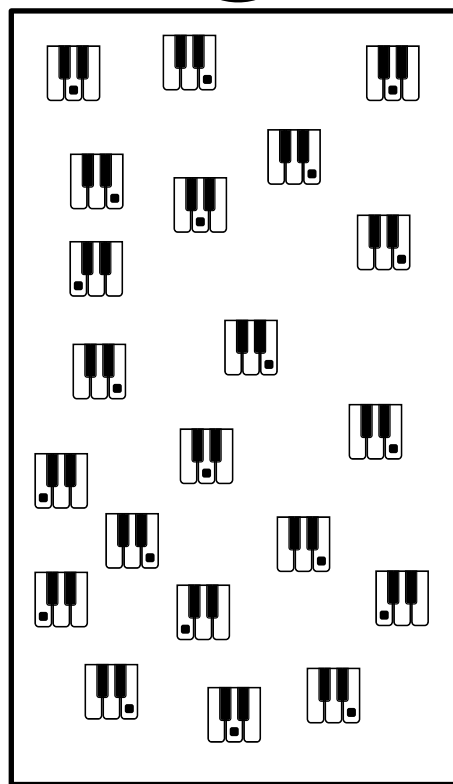
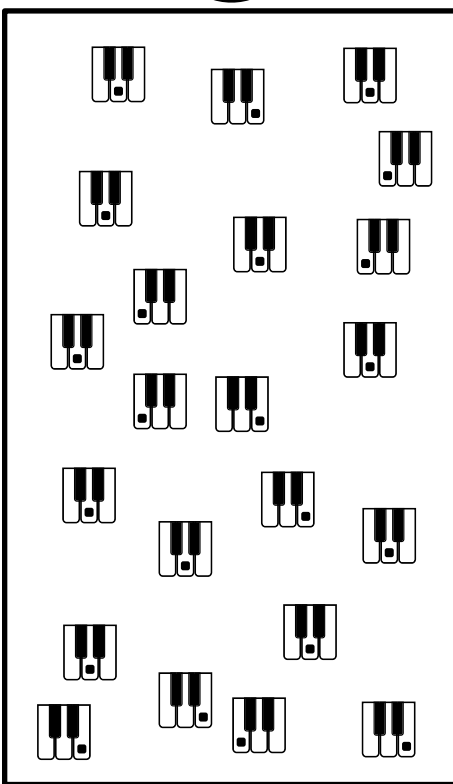
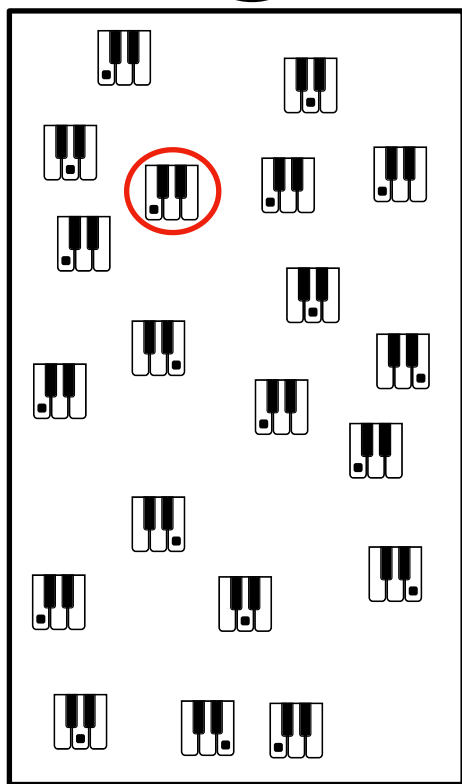

FARV

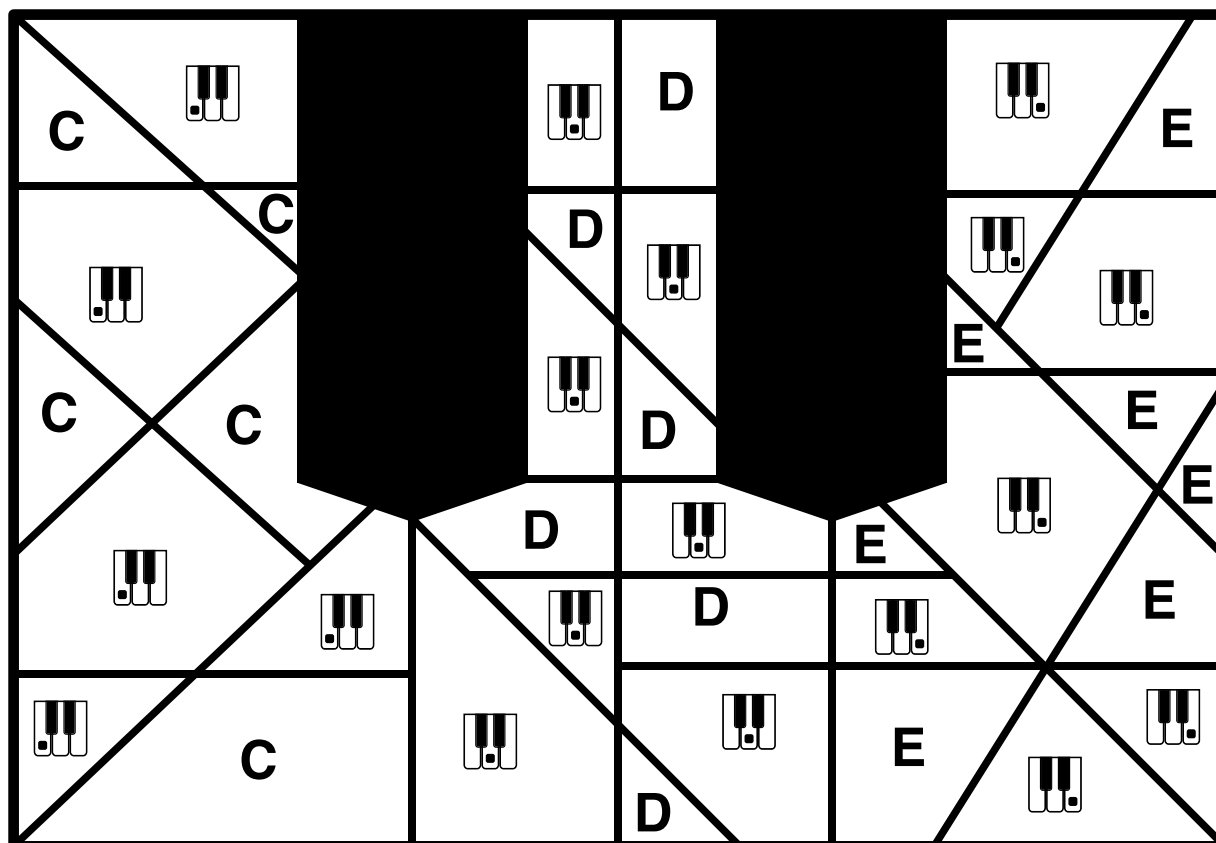

Kopiering til undervisningsbrug må kun ske efter aftale med Copydan Tekst og Node.

TÆL OG SÆT STREGER

Activity for counting and setting chords. On the left, four boxes contain chord letters: **F** (green), **5** (red), **C** (red), **D** (orange), **E** (yellow). The main area is a large circle containing 30 piano keyboard icons. Five icons are crossed out with a red diagonal line, representing the notes F, C, D, E, and another C.

SÆT STREGER

Activity for setting chords. On the left, six boxes each contain two piano keyboard icons. A red line connects the top-left icon of the first box to the 'C' in the third box of the middle column. The middle column has six boxes, each with two chord letters: **C E**, **E C**, **C D**, **E D**, **D C**, **D E**. The right column has six boxes, each with two piano keyboard icons. The far right column has six boxes, each with two chord letters: **E C**, **C D**, **D C**, **E D**, **C E**, **D E**.

Kopiering til undervisningsbrug må kun ske efter aftale med Copydan Tekst og Node.

SÆT STREGER



A grid of 20 piano keyboard icons arranged in a 5x4 pattern. A path of three colored circles is drawn across the grid: a red circle with the letter 'C' is at the bottom-left; a black line connects it to an orange circle with the letter 'D' in the middle; another black line connects 'D' to a yellow circle with the letter 'E' at the top-right. A red line also connects the 'C' circle to the keyboard icon immediately to its left.

SKRIV TONER

Six rows of piano keyboard icons, each with four icons. The first row's icons are colored red, orange, yellow, and red. The other five rows have icons colored yellow, red, orange, and yellow. Each row has a black arrow pointing to a large empty rounded rectangular box for writing the corresponding notes.

Kopiering til undervisningsbrug må kun ske efter aftale med Copydan Tekst og Node.

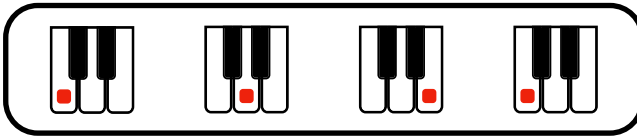
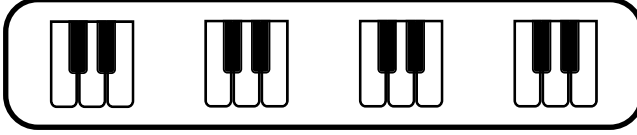
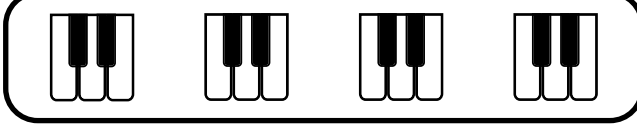
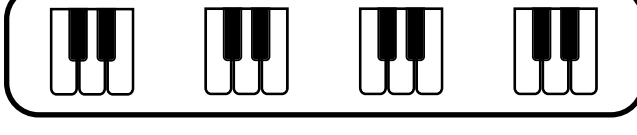
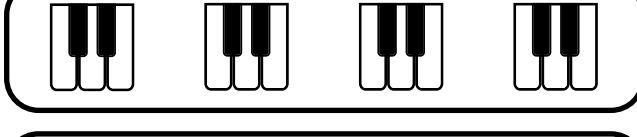
SÆT PRIKKER

C D E C	→	
D E C D	→	
C D E C	→	
E C D E	→	
D E C D	→	
E C D E	→	

SÆT PRIKKER VED E

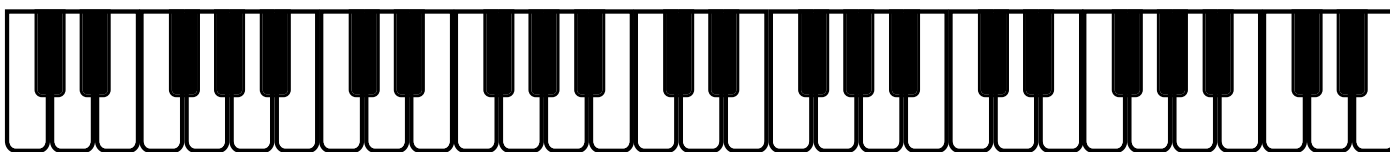
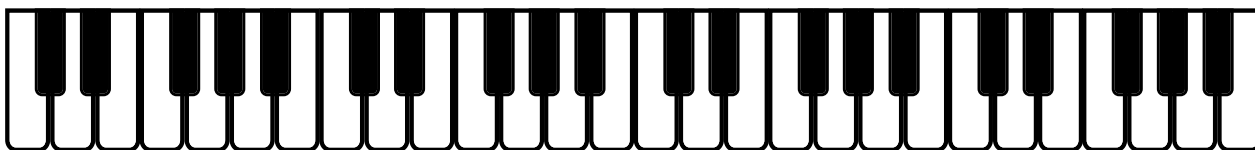
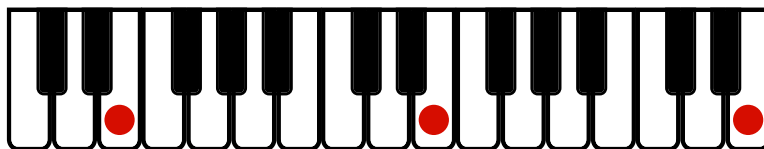

Kopiering til undervisningsbrug må kun ske efter aftale med Copydan Tekst og Node.

SÆT RINGE



F

A 6x6 grid of 36 simplified piano keyboard icons. The icon in the top-left corner (row 1, column 1) is circled in red, indicating the starting point for the ring placement activity.

FIND VEJ

A maze puzzle where the path is defined by simplified piano keyboard icons. A green circle with the letter 'F' is at the bottom-left entrance, and a green circle with a keyboard icon is at the top-right exit. A red line indicates the path from the 'F' to the exit.

Kopiering til undervisningsbrug må kun ske efter aftale med Copydan Tekst og Node.

FARV

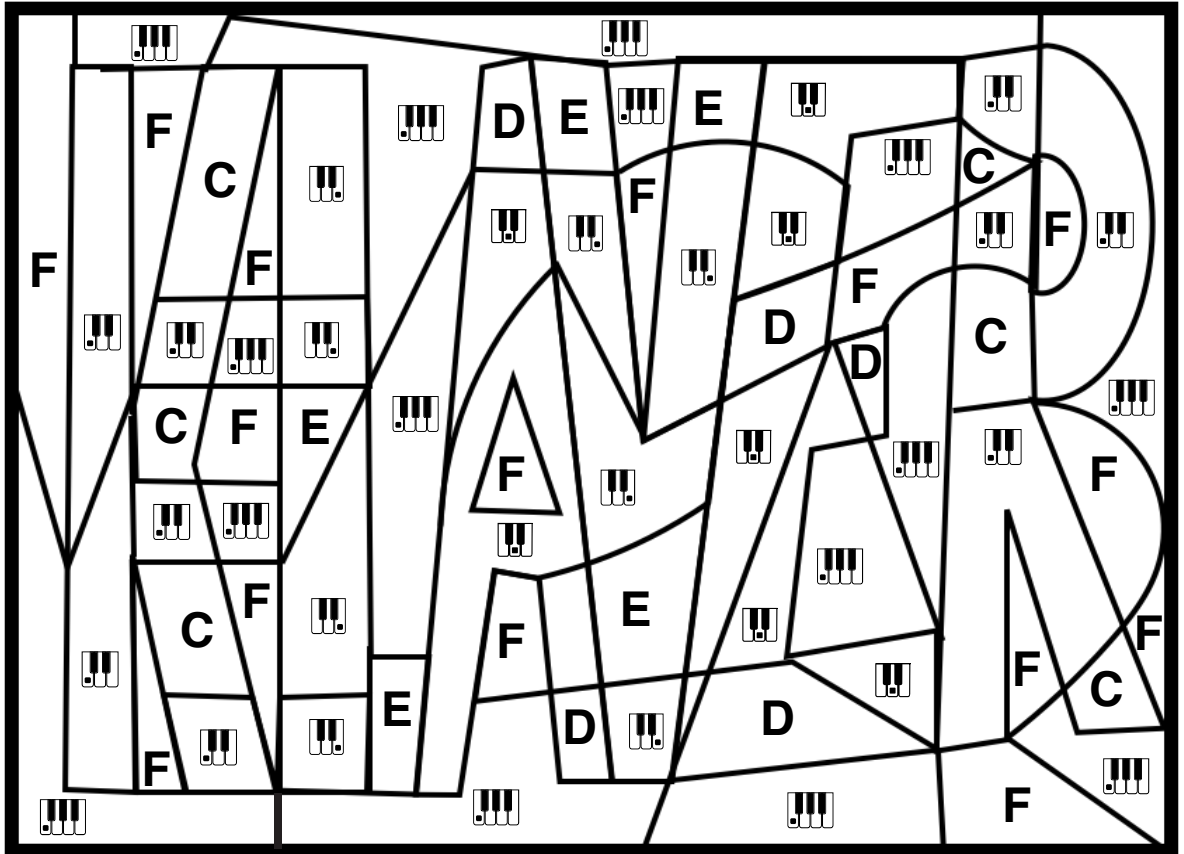

SÆT PRIKKER VED F

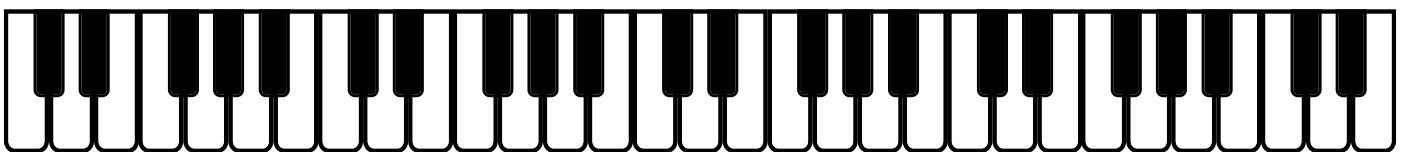
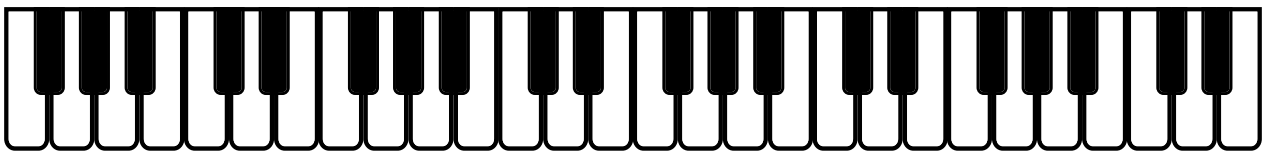
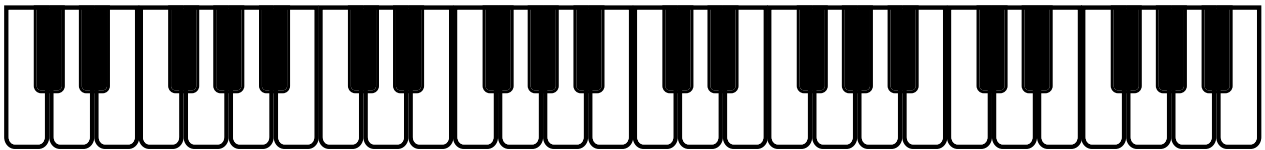
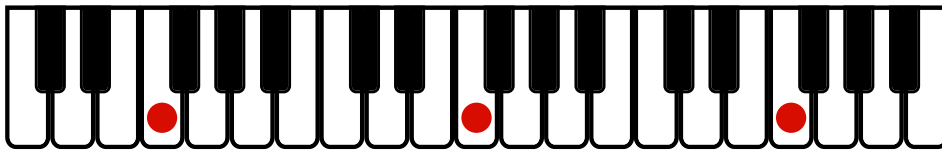

Kopiering til undervisningsbrug må kun ske efter aftale med Copydan Tekst og Node.

SÆT STREGER

SÆT PRIKKER VED G

Kopiering til undervisningsbrug må kun ske efter aftale med Copydan Tekst og Node.

SÆT RINGE

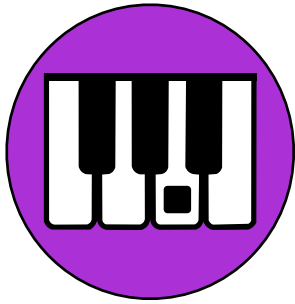

A



FIND VEJ

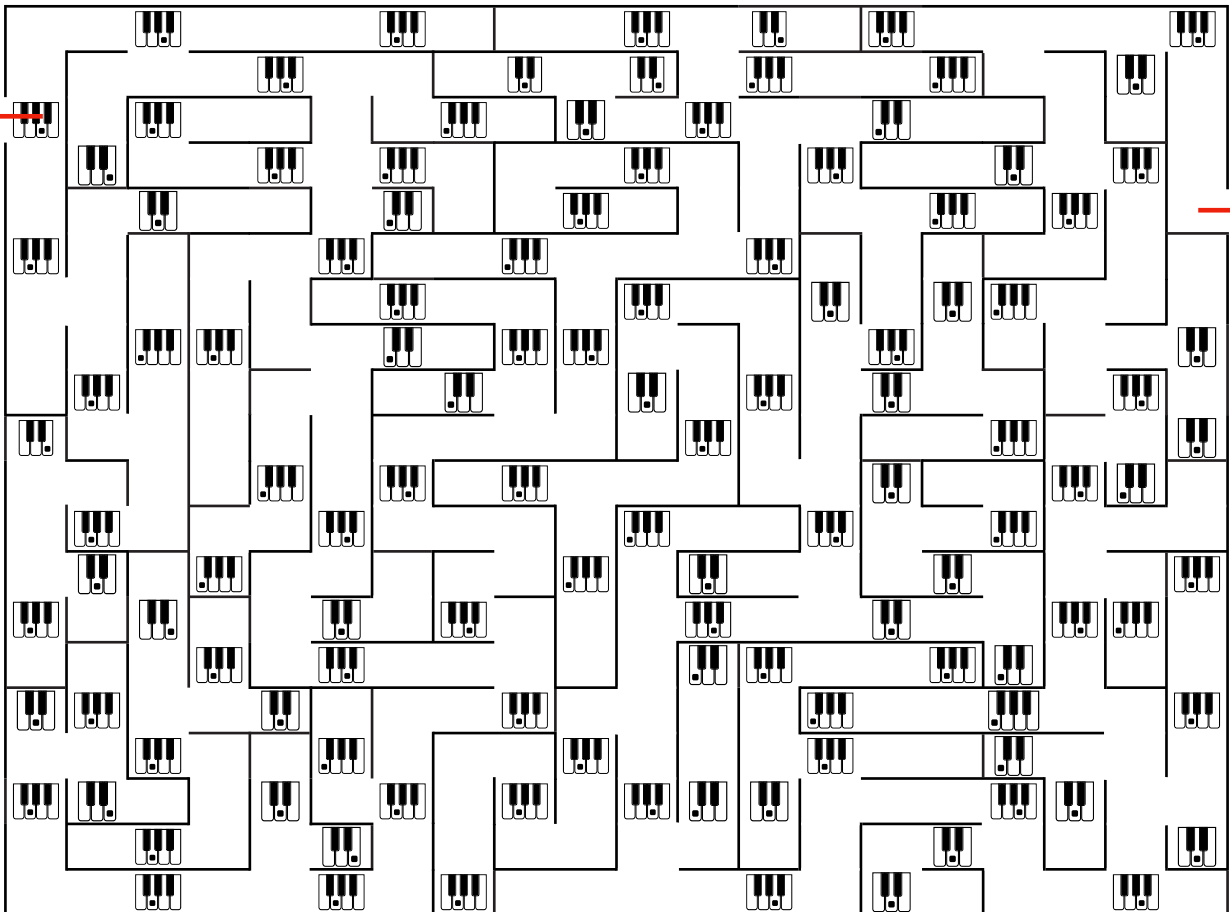

Kopiering til undervisningsbrug må kun ske efter aftale med Copydan Tekst og Node.

FARV

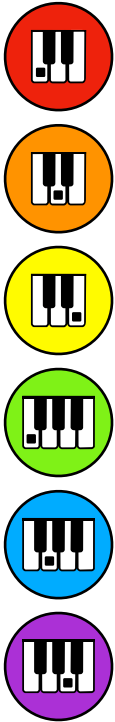

	G		D			D		D				D		G	
		D			A	A							D		G
C				A			A			A	A				C
	C							E					D	C	
		D				E						A			G
G			A	A			E		E				D	G	
C		D			E			E					D		C
				A	A	A			A		A	A			
	G	D	A	A			A			A	A				G
G		D					F		F				D		G
C					F	F				F			D	C	
C				A		F		F		F	A	A			C
		D			F		F			F			D	G	
G			A		F	F		F	F		A	A	D		G
	C	D				F	F		F	F	A	A			
C		D		D	D			D		D		D	D		C

SÆT PRIKKER VED A

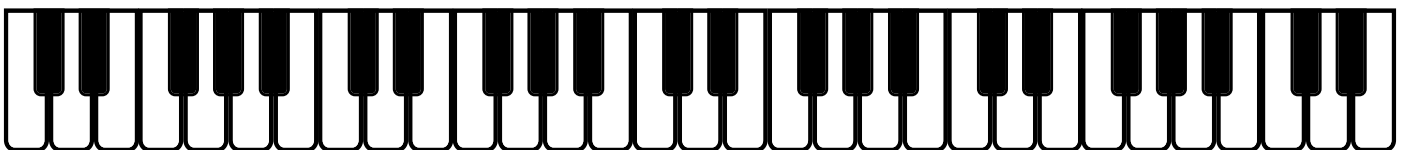
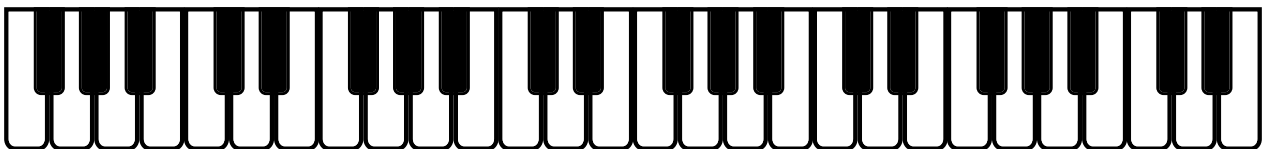
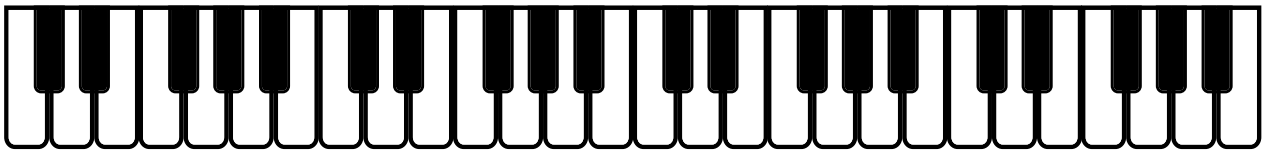
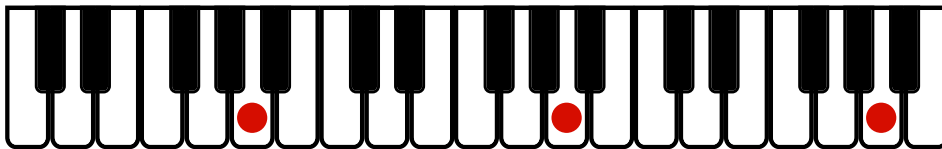

Kopiering til undervisningsbrug må kun ske efter aftale med Copydan Tekst og Node.

SÆT RINGE

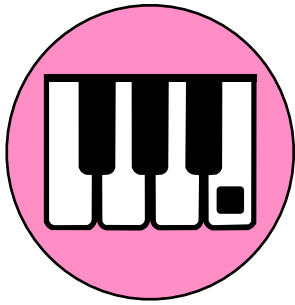

B

FIND VEJ

Kopiering til undervisningsbrug må kun ske efter aftale med Copydan Tekst og Node.

TÆL OG SÆT STREGER

13

B



B





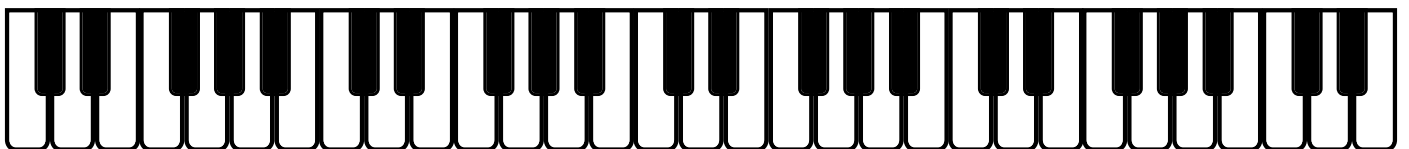
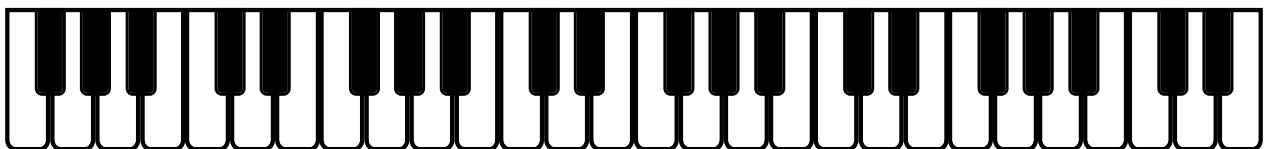
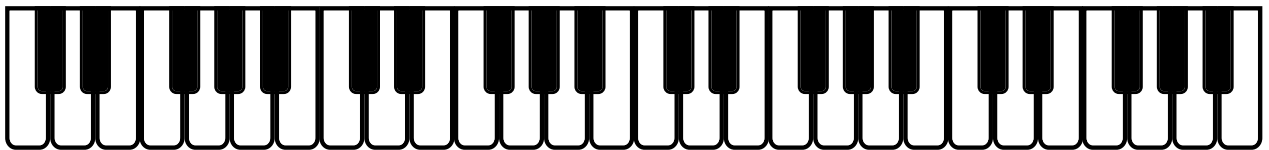
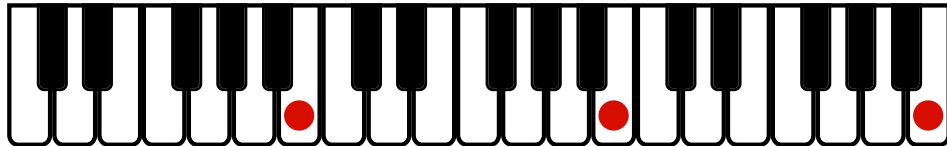















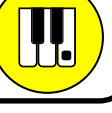

Four vertical columns of piano keyboard icons. Each icon shows a segment of a keyboard with three keys highlighted in pink. The first column contains 13 icons, with the 5th icon from the top crossed out with a red diagonal line. The second and third columns each contain 12 icons. The fourth column contains 13 icons. The columns are separated by vertical lines, and the first and last columns are also bounded by horizontal lines at the top and bottom.

SÆT PRIKKER VED B







Kopiering til undervisningsbrug må kun ske efter aftale med Copydan Tekst og Node.

SKRIV TONER

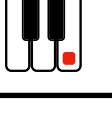
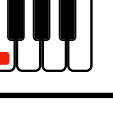
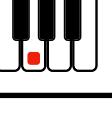
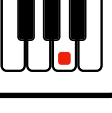
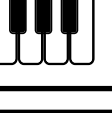
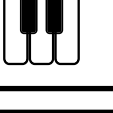
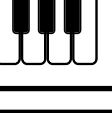
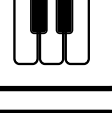
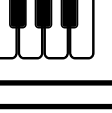
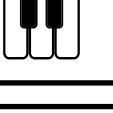
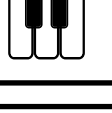
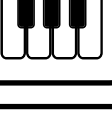
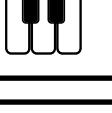
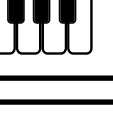
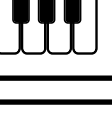
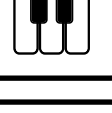
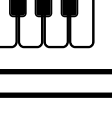
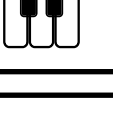
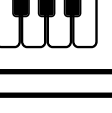
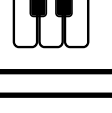
				→	D F E C
				→	
				→	
				→	
				→	
				→	

SÆT PRIKKER

E	F	G	A	→				
B	C	F	D	→				
A	E	C	G	→				
D	F	B	E	→				
G	C	A	D	→				
A	F	G	B	→				

Kopiering til undervisningsbrug må kun ske efter aftale med Copydan Tekst og Node.

FARV

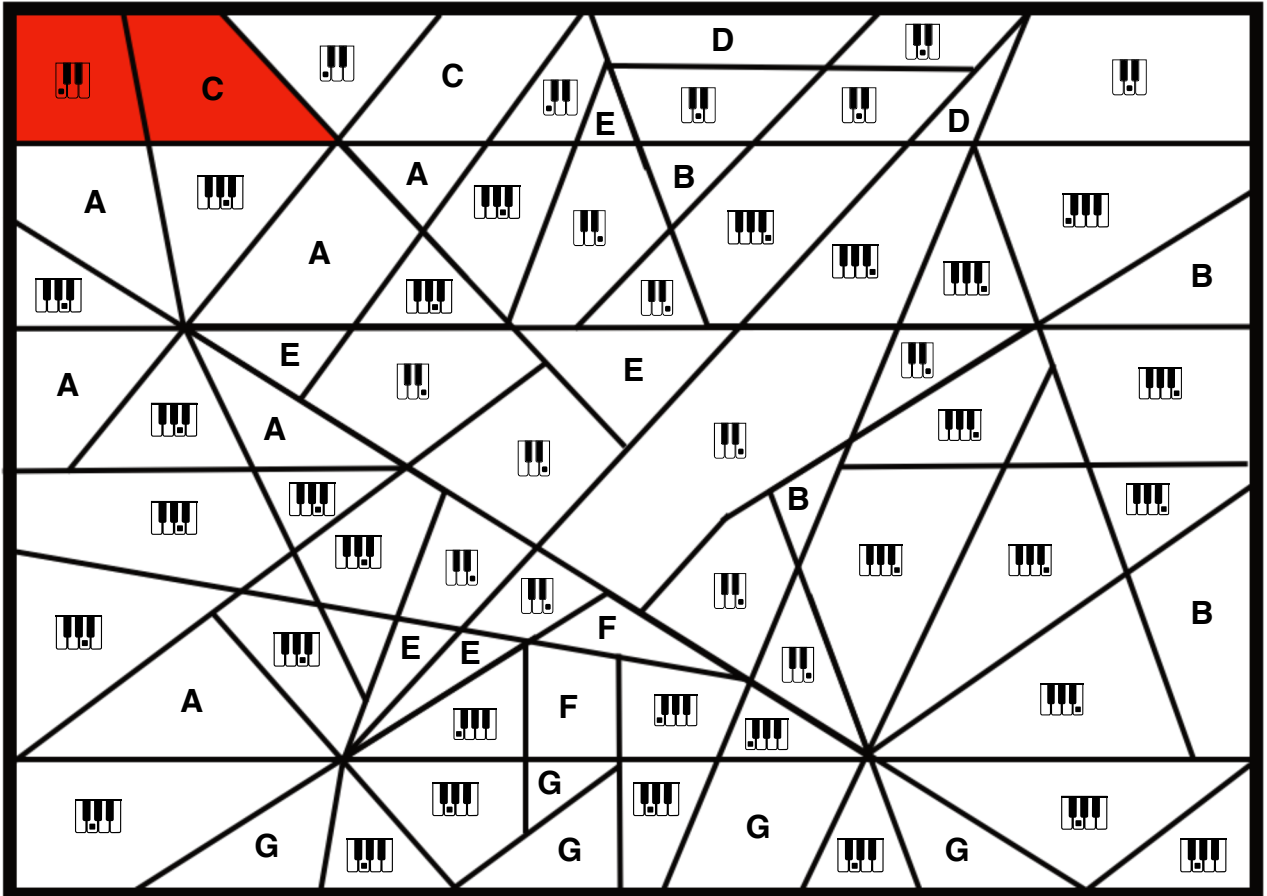

SKRIV TONER OG SÆT STREGER

Kopiering til undervisningsbrug må kun ske efter aftale med Copydan Tekst og Node.

SÆT STREGER

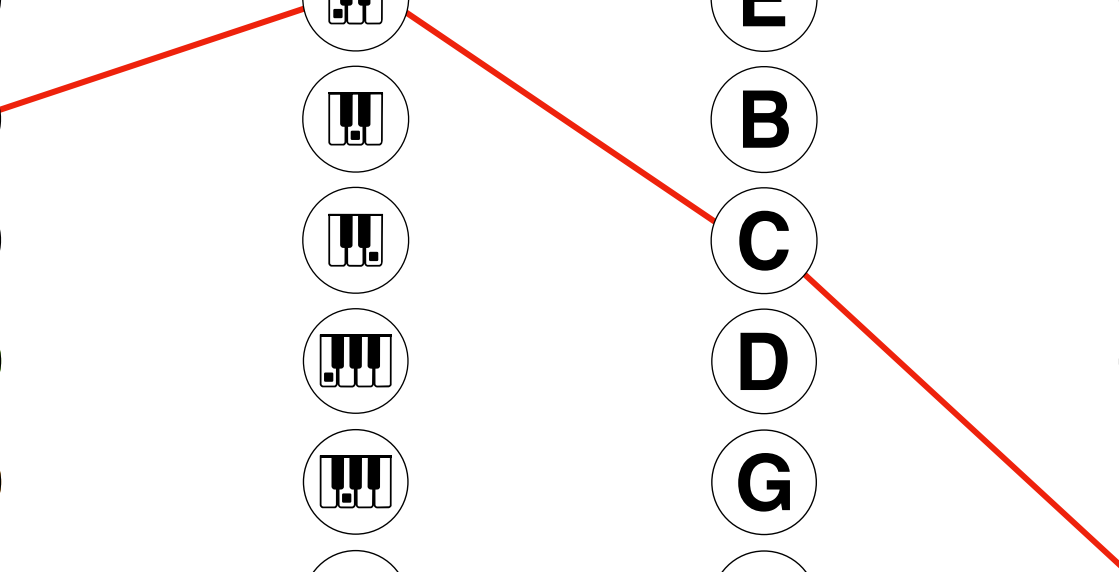
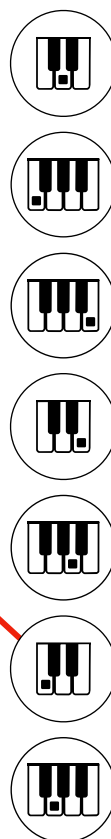

TEGN EFTER

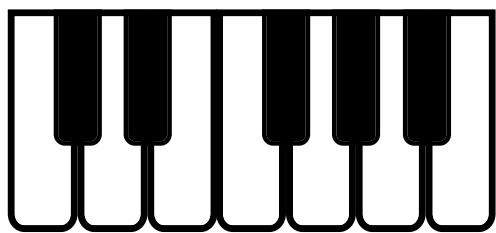
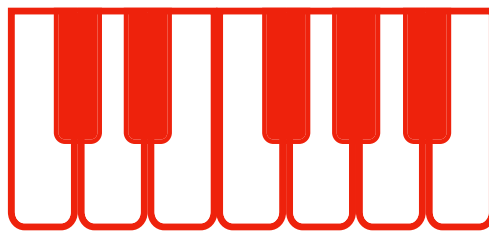
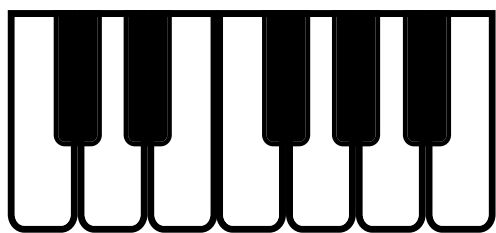

Kopiering til undervisningsbrug må kun ske efter aftale med Copydan Tekst og Node.

SÆT PRIKKER

C D F	→	
E G B	→	
D F G	→	
C E A	→	
E A B	→	
C D G	→	
F G B	→	
G A B	→	
C D E	→	

E F B	→	
D F A	→	
C E G	→	
D E F	→	
F G A	→	
C A B	→	
C F G	→	
C G B	→	
D F A	→	

SKRIV TONER

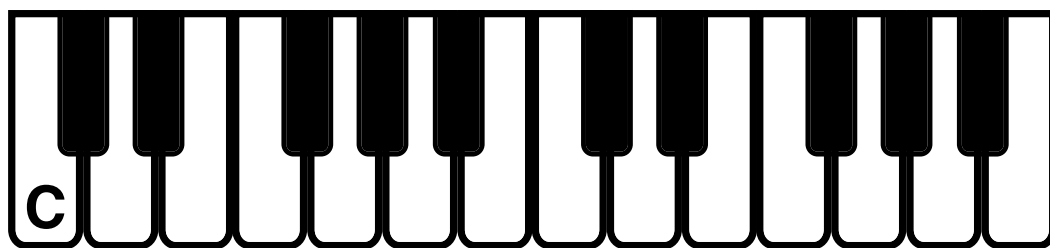
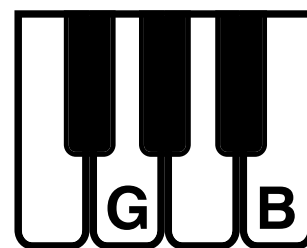
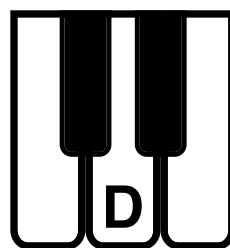
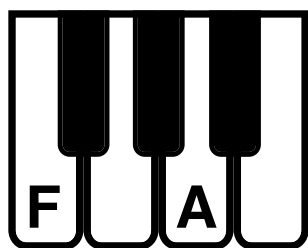
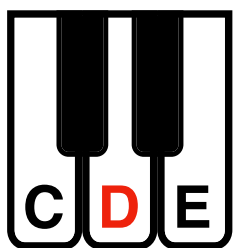

Kopiering til undervisningsbrug må kun ske efter aftale med Copydan Tekst og Node.

SKRIV TONER OG SÆT STREGER

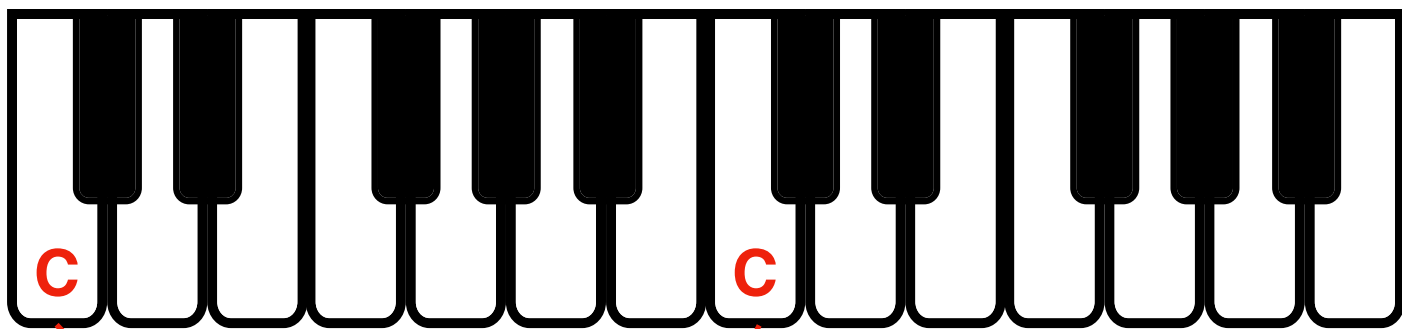

A

B

C

D

E

F

G

SKRIV TONER

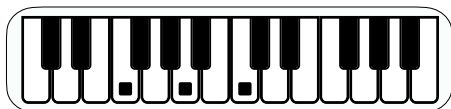

F A C

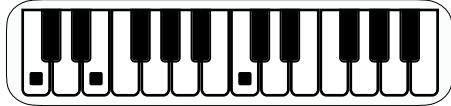
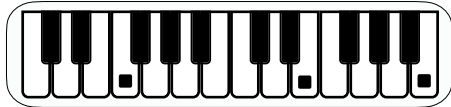
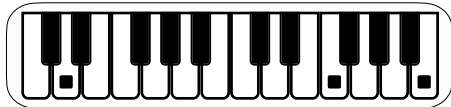
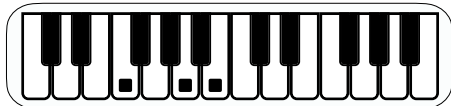
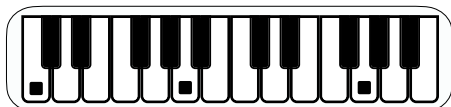

Kopiering til undervisningsbrug må kun ske efter aftale med Copydan Tekst og Node.

SÆT STREGER

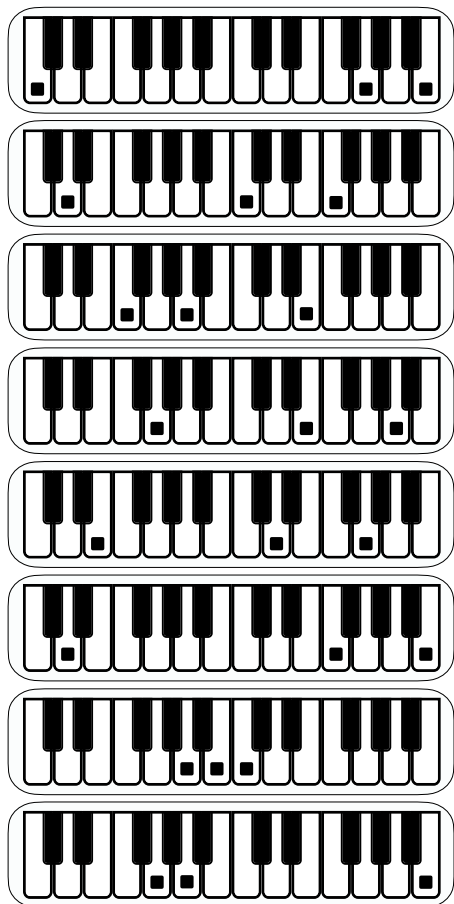

A	B	C
G	A	B
D	C	F
C	G	B
F	A	E
G	E	A
E	D	G
D	F	B

SÆT PRIKKER

C D G A D	→	
D F A E B	→	
C E G A F	→	
A B C D E	→	
B C D G A	→	
F G C F B	→	

Kopiering til undervisningsbrug må kun ske efter aftale med Copydan Tekst og Node.

SKRIV TONER

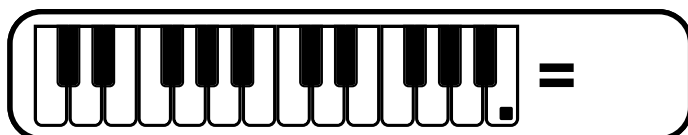
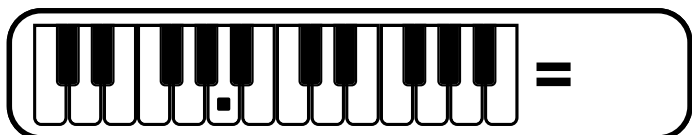
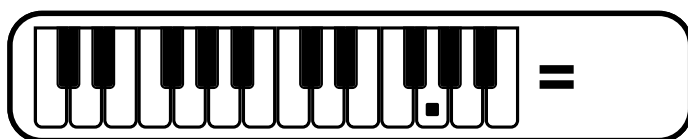
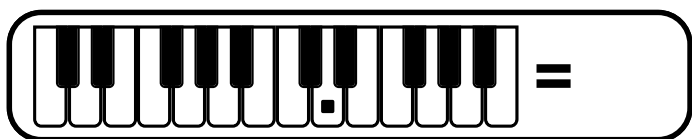
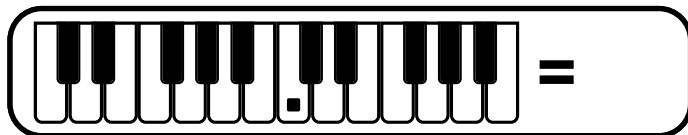
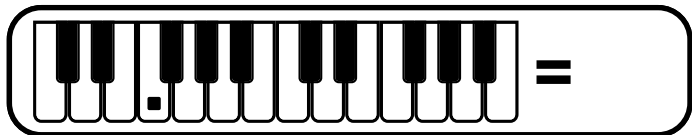
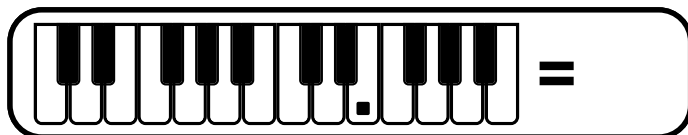
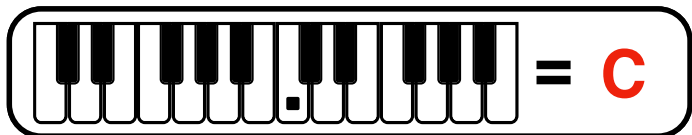

SÆT PRIKKER

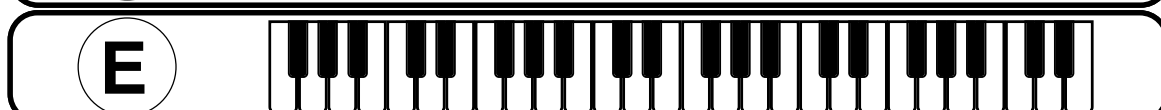
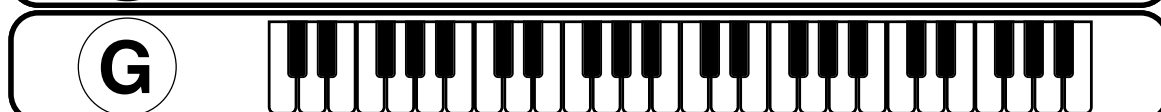
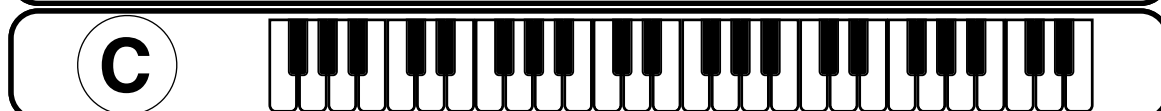
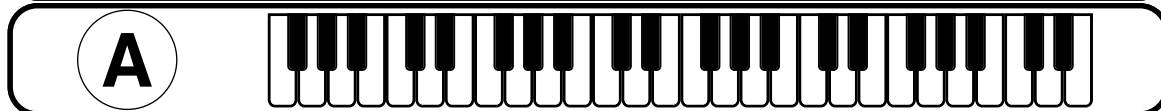
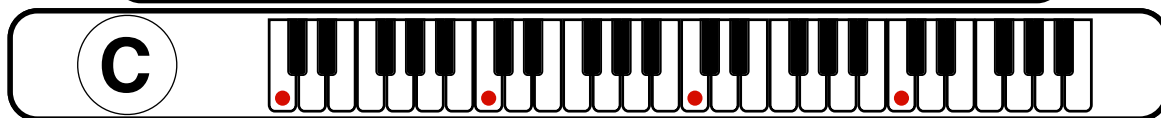

Kopiering til undervisningsbrug må kun ske efter aftale med Copydan Tekst og Node.

SUDOKU 4X4

			C

	G		

SUDOKU 4X4

		F	

			D

Kopiering til undervisningsbrug må kun ske efter aftale med Copydan Tekst og Node.

SUDOKU 4X4

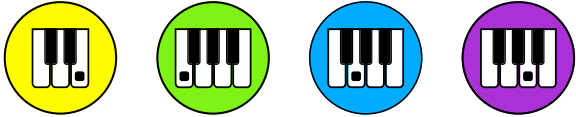

		F	

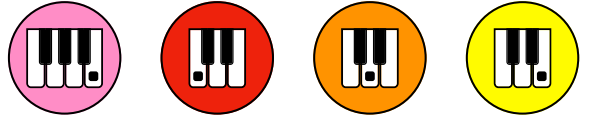

			D

SUDOKU 4X4

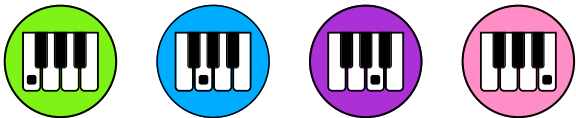

		A	

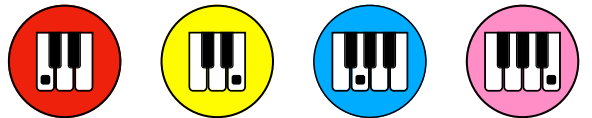

		E	

Kopiering til undervisningsbrug må kun ske efter aftale med Copydan Tekst og Node.

SUDOKU 7X7



	B					

SUDOKU 7X7



						B

Kopiering til undervisningsbrug må kun ske efter aftale med Copydan Tekst og Node.

Klaver

2. del

De 5 sorte tangenter

The diagram illustrates the five black keys on a piano keyboard, each labeled with its sharp name and the three natural/flat names it covers. The white keys are labeled with their natural names. Small keyboard icons are placed above and below the main diagram.

Black Key (Sharp)	White Keys (Natural/Flat)
C#	Cis, D \flat , Des
D#	Dis, E \flat , Es
F#	Fis, G \flat , Ges
G#	Gis, A \flat , As
A#	Ais, B \flat , Bes

Kopiering til undervisningsbrug må kun ske efter aftale med Copydan Tekst og Node.

SKRIV EFTER OG SÆT RINGE



=

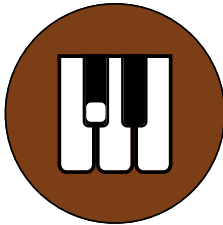

=



C# C#

Cis Cis

Db Db

Des Des

FIND VEJ

Kopiering til undervisningsbrug må kun ske efter aftale med Copydan Tekst og Node.

SÆT PRIKKER

Cis	F	C	→			
G	Des	E	→			
D	Cis	F	→			
B	A	C#	→			
C	D_b	D	→			
Cis	G	E	→			
A	D	Des	→			
C#	G	D_b	→			

SÆT PRIKKER

C#
Cis Des
D_b

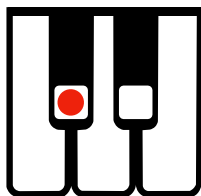

C#
Cis Des
D_b

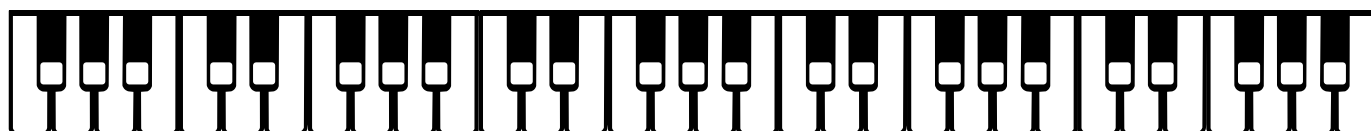
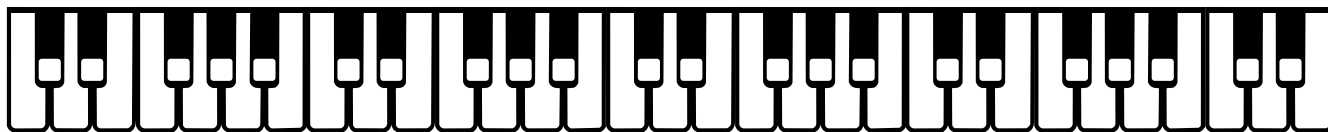
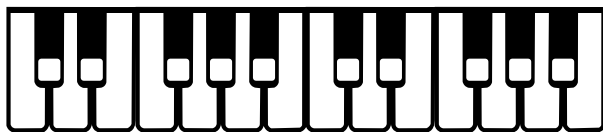

Kopiering til undervisningsbrug må kun ske efter aftale med Copydan Tekst og Node.

SKRIV EFTER OG SÆT RINGE

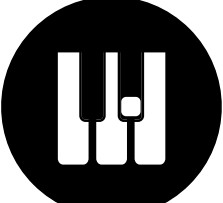
D# = **Dis**  **E \flat** = **Es**

D# D# **Dis Dis** **E \flat E \flat** **Es Es**

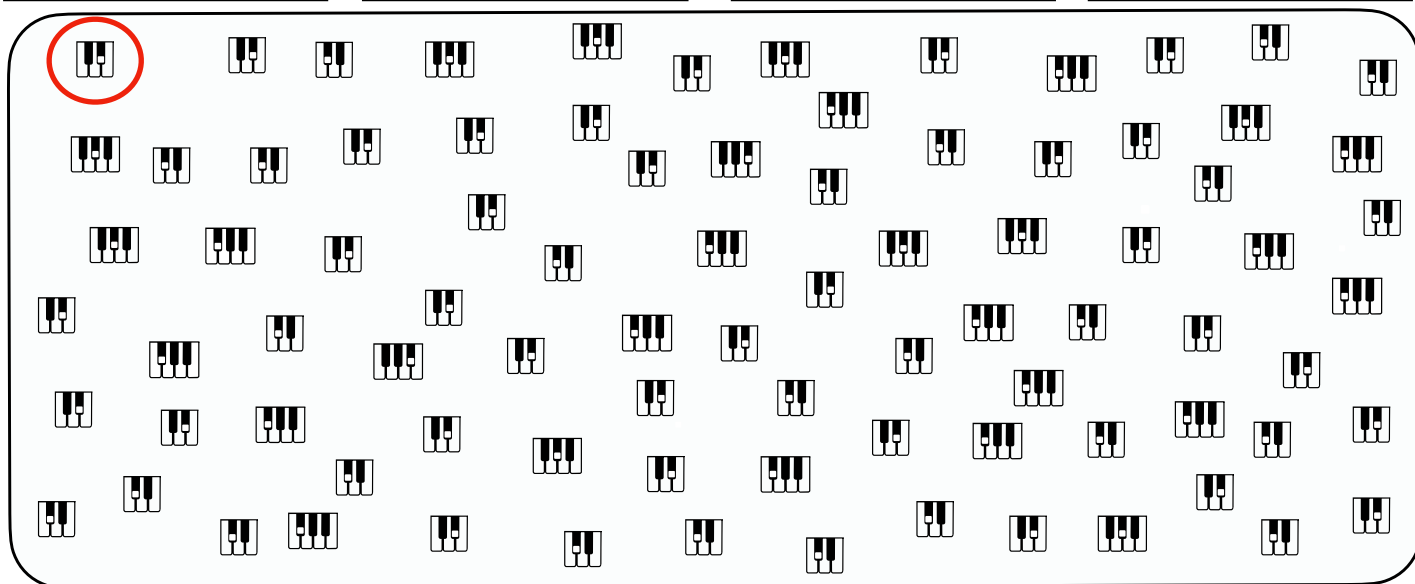

FIND VEJ

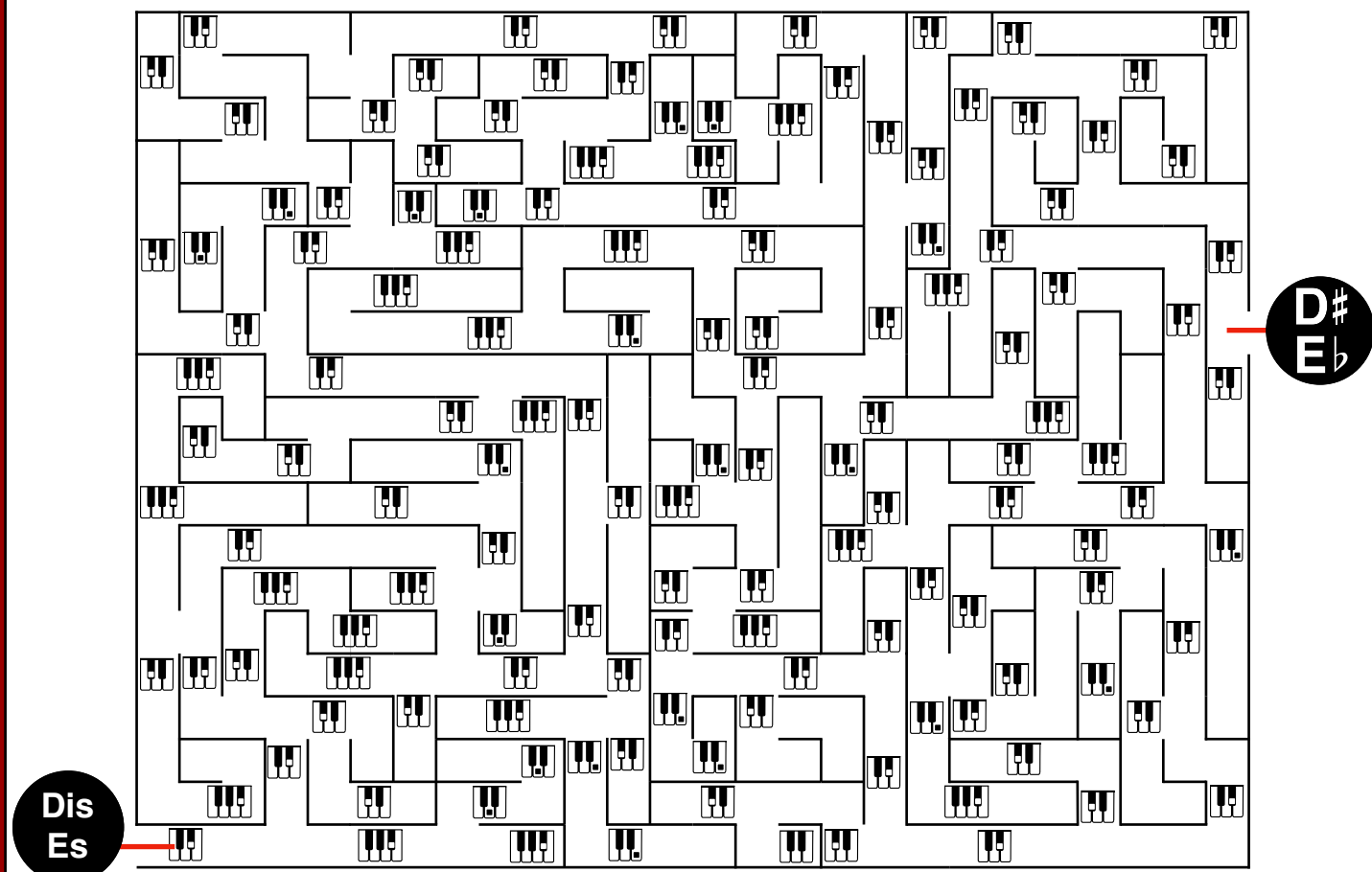

Kopiering til undervisningsbrug må kun ske efter aftale med Copydan Tekst og Node.

SÆT STREGER

A 6x9 grid of piano keyboard icons. In the center, a black circle contains the notes **D#**, **Dis**, **Es**, and **E♭**. A red line connects this circle to the keyboard icon in the 4th row, 9th column.

FIND VEJ

A 12x12 grid of piano keyboard icons. A red line starts from a keyboard icon in a circle on the left edge (row 6, column 1) and ends at a keyboard icon in a circle on the right edge (row 5, column 12).

Kopiering til undervisningsbrug må kun ske efter aftale med Copydan Tekst og Node.

FARV



	G		C						G	
	C				C		G	C		G
Des	E					D#	E	E	Des	C#
	E	E \flat	E	E	Dis	Es	E \flat		E	D \flat
	C#		Dis		E	Es	E		E	C#
Cis	E		Es	E		Dis	Dis		E	D \flat
	D#	E	E	E \flat	E	E \flat	E	E	E	Cis
A	F				F		D	F	F	B
	F	F	F	D		D		F		B

SÆT PRIKKER

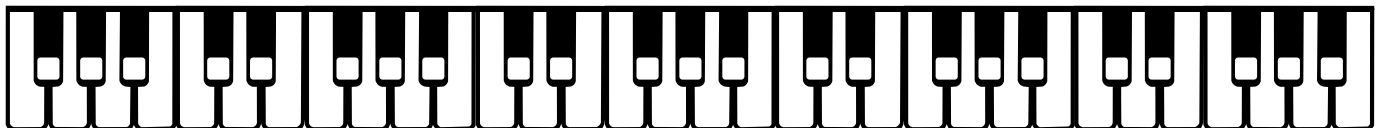
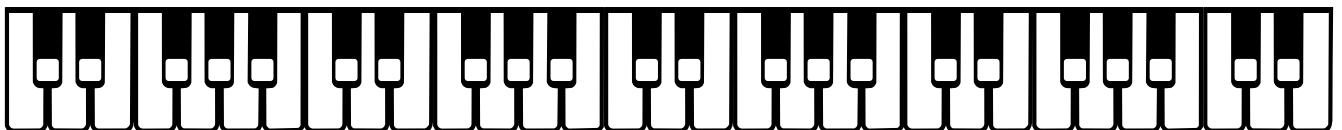
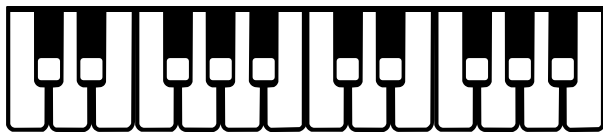
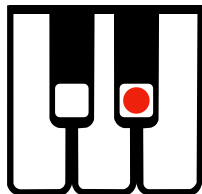

Kopiering til undervisningsbrug må kun ske efter aftale med Copydan Tekst og Node.

SKRIV EFTER OG SÆT RINGE



=

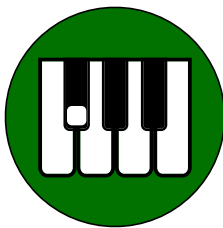

=



F# F#

Fis Fis

Gb Gb

Ges Ges

FIND VEJ

Kopiering til undervisningsbrug må kun ske efter aftale med Copydan Tekst og Node.

SÆT STREGER

A 6x9 grid of piano keyboard icons. A red line connects the top-left icon to a central green circle. The circle contains the text **F#**, **Fis Ges**, and **G \flat** .

TÆL OG SÆT STREGER

12 **F#** **G \flat**  **Fis Ges**

A 4x10 grid of piano keyboard icons. The first and third columns are highlighted with green borders. The top-left icon in the first column has a red diagonal line through it.

Kopiering til undervisningsbrug må kun ske efter aftale med Copydan Tekst og Node.

SÆT STREGER

	D# E\flat	F# D	
	C# D\flat	C# A	
	G\flat C#	D\flat G\flat	
	D# G\flat	B C#	
	F# D#	F# E	
	D\flat F#	C D#	
	C# D#	F G\flat	
	F# G\flat	D# D\flat	
	E\flat C#	G E\flat	

SÆT PRIKKER

F#
Fis Ges
G \flat

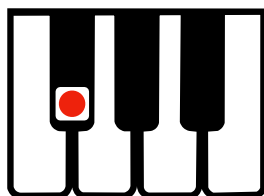

F#
Fis Ges
G \flat

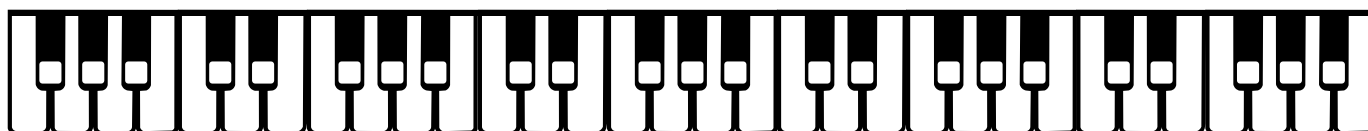
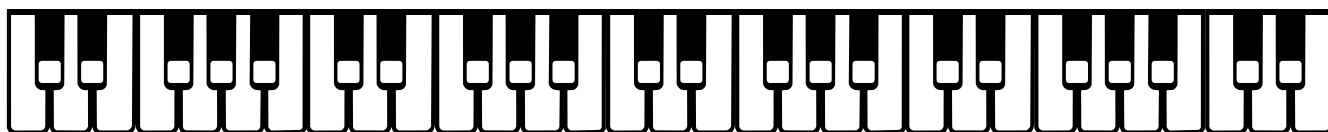
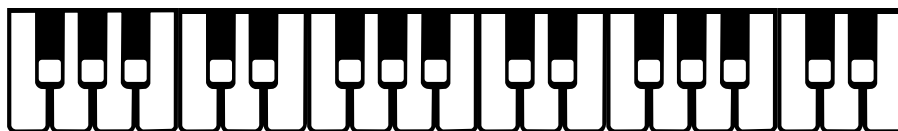
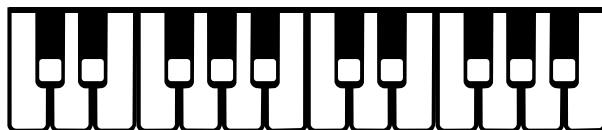

Kopiering til undervisningsbrug må kun ske efter aftale med Copydan Tekst og Node.

SKRIV EFTER OG SÆT RINGE



=

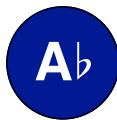
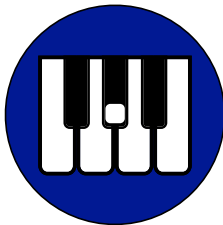

=



G# **G#**

Gis **Gis**

Ab **Ab**

As **As**

FIND VEJ



Kopiering til undervisningsbrug må kun ske efter aftale med Copydan Tekst og Node.

SÆT STREGER

A 6x9 grid of piano keyboard icons. A central blue circle contains the notes G#, Gis, As, and Ab. A red line connects the top-left icon to the G# note in the central circle.

FARV

A coloring page for a hand holding a piano keyboard. The hand and keyboard are divided into sections labeled with musical notes. A legend on the left shows six colored keyboard icons: blue, green, yellow, black, orange, and brown.

Kopiering til undervisningsbrug må kun ske efter aftale med Copydan Tekst og Node.

SKRIV TONER

				→	F	Dis Es	C	B
				→				
				→				
				→				
				→				
				→				
				→				

SÆT PRIKKER

G#
Gis As
Ab

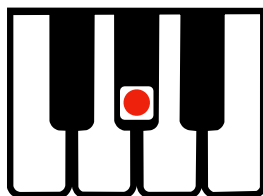

G#
Gis As
Ab

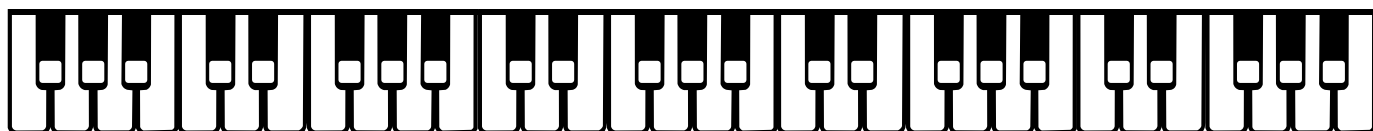
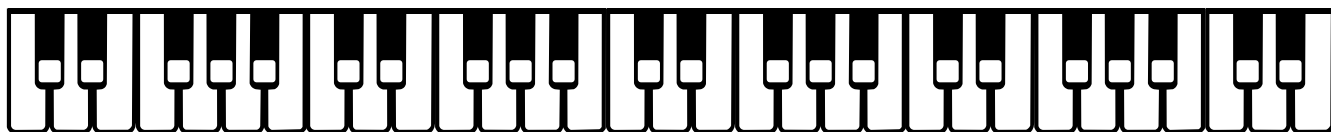
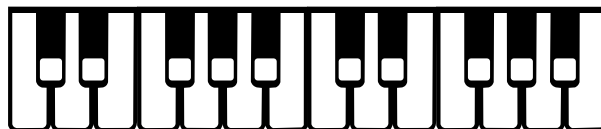

Kopiering til undervisningsbrug må kun ske efter aftale med Copydan Tekst og Node.

SKRIV EFTER OG SÆT RINGE

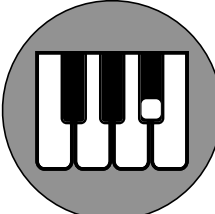
A# = Ais  Bb = Bes

A# A#

Ais Ais

Bb Bb

Bes Bes

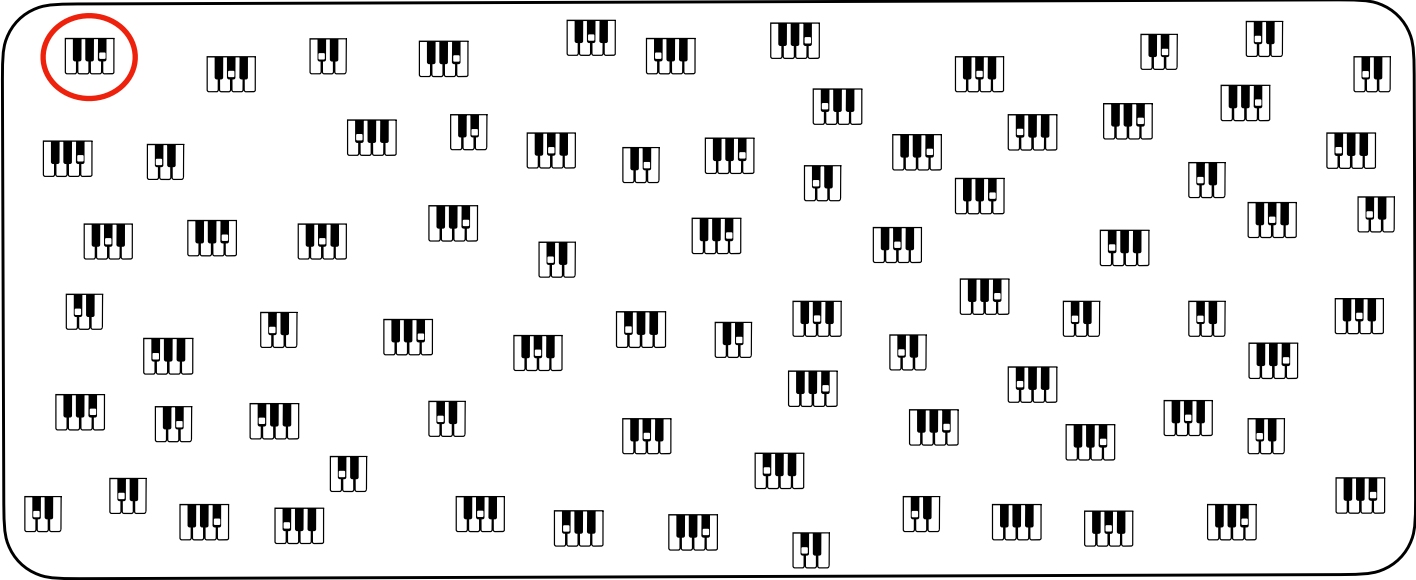

SÆT STREGER

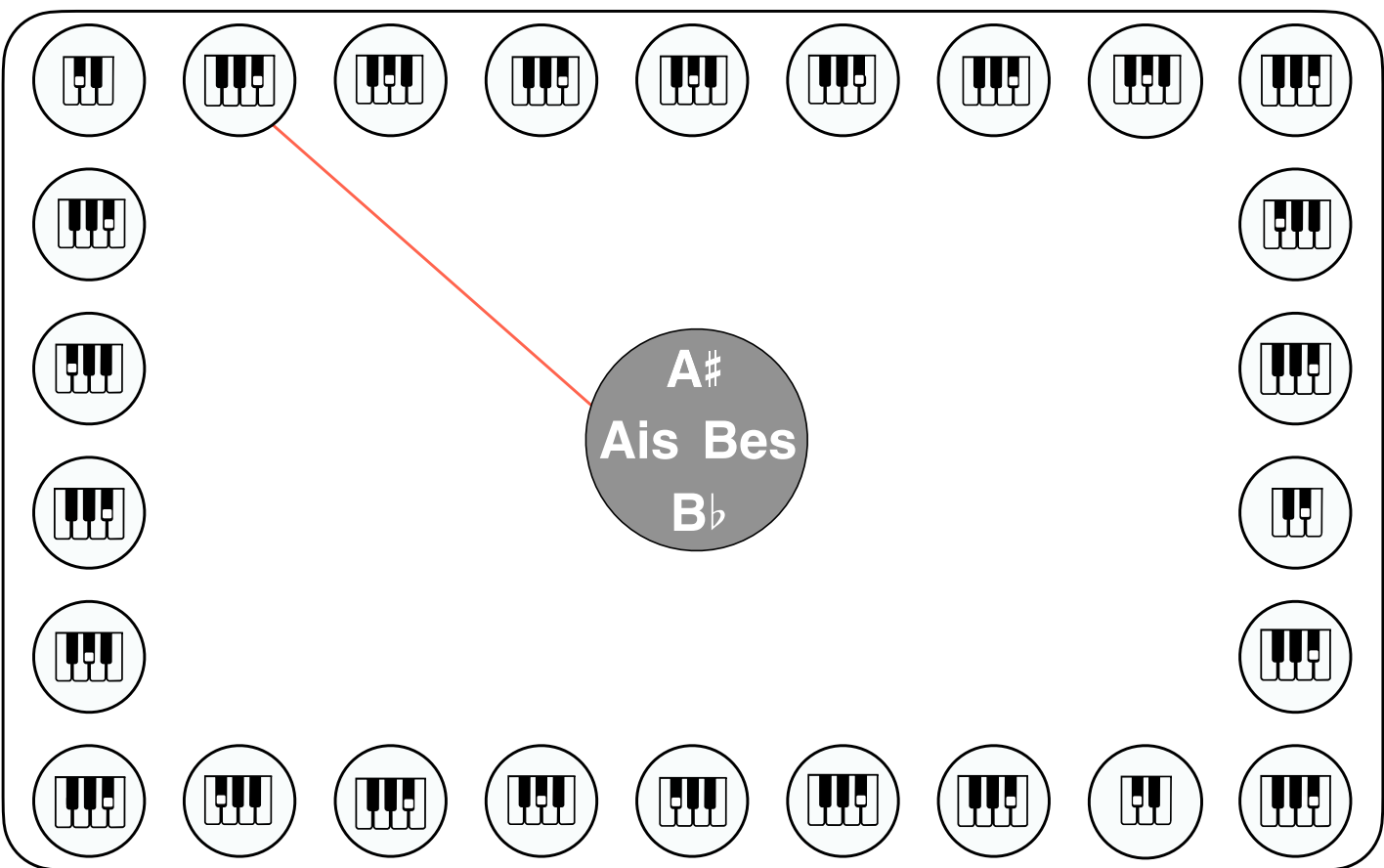

Kopiering til undervisningsbrug må kun ske efter aftale med Copydan Tekst og Node.

FIND VEJ

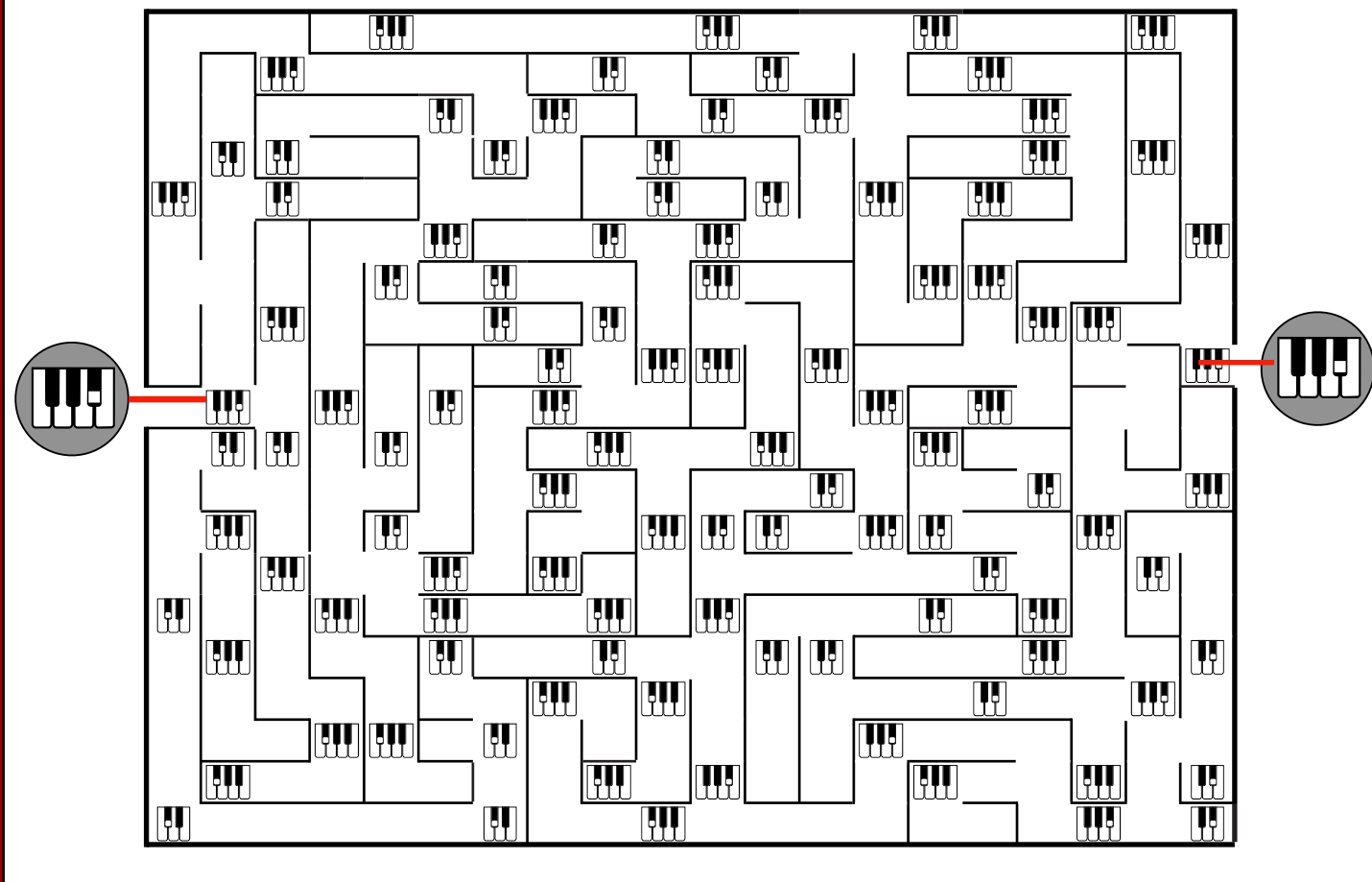

SÆT RINGE

A#
Bb

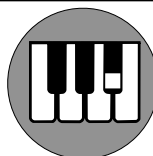

Ais
Bes

B	S	S	A	A	S	I	A	I	S	I	B	A	S	B
E	S	B	S	A	S	I	S	O	S	S	E	N	S	E
S	A	E	S	S	S	D	I	I	B	E	B	O	A	S
S	I	S	S	I	I	S	E	A	S	I	E	D	S	S
A	I	S	S	B	E	S	S	I	S	S	S	E	S	A
I	E	I	A	E	E	A	O	S	O	I	E	A	I	S
S	S	M	U	S	I	K	B	E	S	D	A	B	I	A
A	I	S	H	I	E	S	D	S	B	S	I	S	S	B
S	A	I	S	B	B	E	S	S	A	S	S	S	O	S

Kopiering til undervisningsbrug må kun ske efter aftale med Copydan Tekst og Node.

FARV

A large triangular graphic divided into many sections, each containing a piano keyboard icon and a musical note name. The notes include Ais, B_b, B, A, A_s, G_{is}, A_b, G_#, F_{is}, F_#, G_b, G_{es}, F, E, E_s, E_b, D_{is}, D_#, D, C_#, D_{es}, D_b, C_{is}, C, and C_#.

SÆT PRIKKER

A#
Ais Bes
B_b

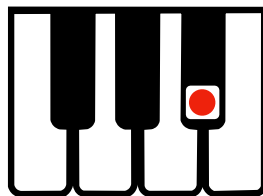



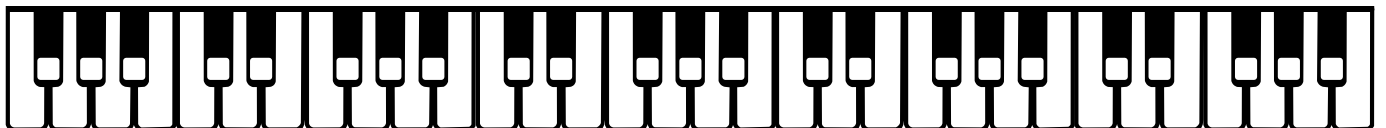
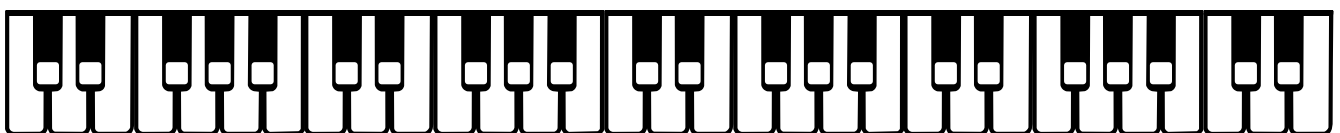
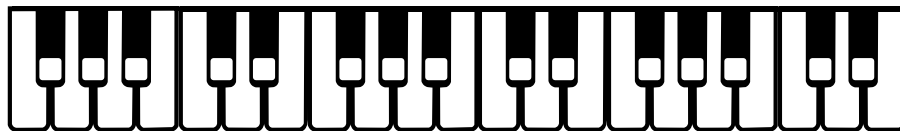
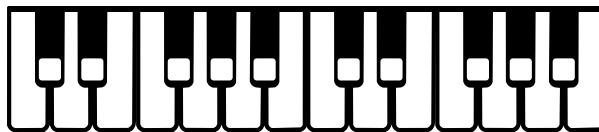















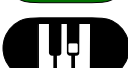

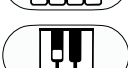

A#
Ais Bes
B_b







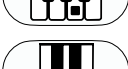



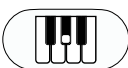





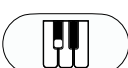





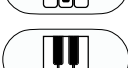

Kopiering til undervisningsbrug må kun ske efter aftale med Copydan Tekst og Node.

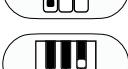
SÆT STREGER

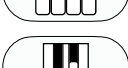
B		Fis	
A#		Cis	
A		Dis	
G#		Gis	
G		Ais	
F#		A	
F		B	
E		C	
C		D	
D		E	
C#		F	
D#		G	

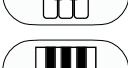
SÆT STREGER

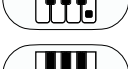
E		D_b	
B		G_b	
Ges		F	
A		C	
As		E_b	
G		A_b	
Bes		E	
C		A	
Es		B	
F		D	
D		G	
Des		B_b	

Kopiering til undervisningsbrug må kun ske efter aftale med Copydan Tekst og Node.

SÆT PRIKKER











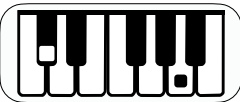
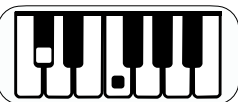

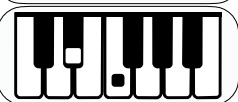
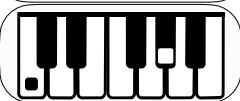
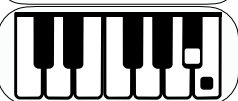



C# E _b F		Des E Fis	
D# E G _b		Cis F As	
D G# B _b		D Fis Bes	
F# G A _b		Dis G As	
D _b A A#		C Es Ais	
E _b G# B		Ges Gis B	
C G _b A#		Cis Es A	
D# F B _b		Des Ges Ais	
C# F# A _b		Dis Gis Bes	

SÆT STREGER





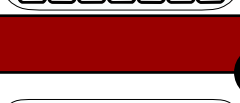









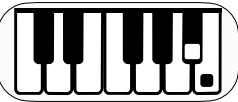
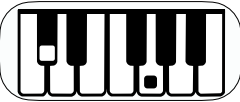

Cis	A _b		F#	Bes
Dis	G _b		G#	Des
Fis	B _b		A#	Es
Gis	D _b		D#	Ab
Ais	E _b		C#	Ges

Kopiering til undervisningsbrug må kun ske efter aftale med Copydan Tekst og Node.

SKRIV TONER MED # OG IS

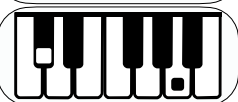
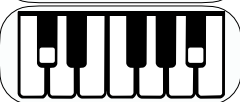
	→	C# A		→	Cis F
	→			→	
	→			→	
	→			→	
	→			→	
	→			→	
	→			→	
	→			→	
	→			→	
	→			→	

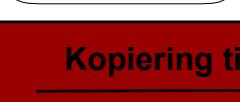
SKRIV TONER MED ♭, ES OG S

	→	D# A		→	C Bes
	→			→	
	→			→	
	→			→	
	→			→	
	→			→	
	→			→	
	→			→	
	→			→	
	→			→	

Kopiering til undervisningsbrug må kun ske efter aftale med Copydan Tekst og Node.

SÆT STREGER

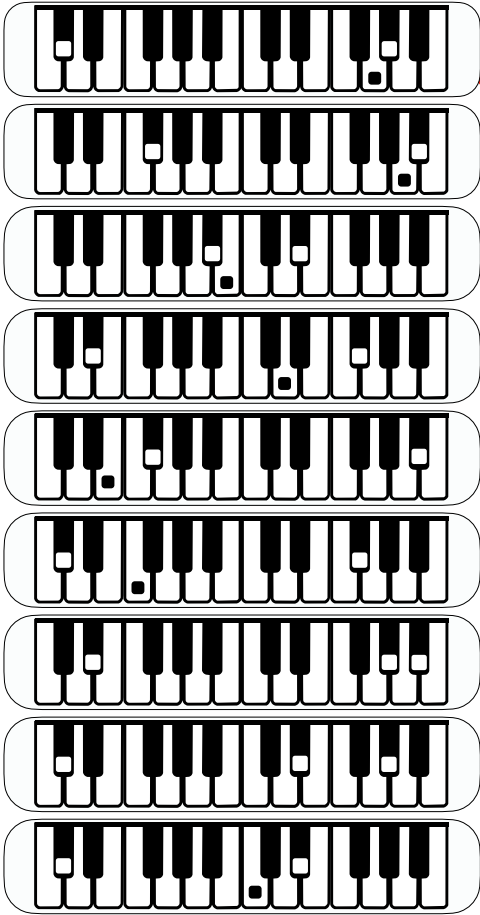

D_b Es Gis

C# F Ges

E Fis B_b

F# A Bes

Cis C E_b

A# B Es

Dis D G_b

Des G G#

D# As Ais

SÆT PRIKKER

D As C Fis B



D_b Ges Gis F A#

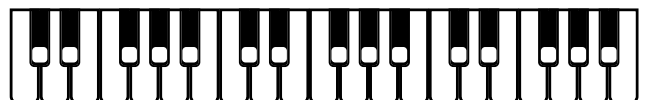

F# Cis A Es B_b

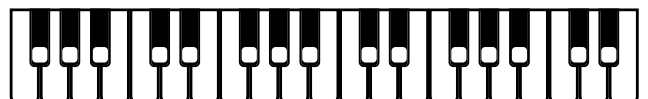

Des Fis E_b G# G

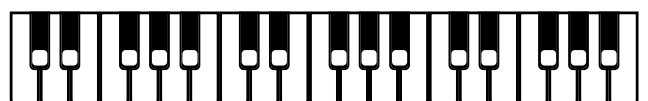

Ges B C# Gis D_b

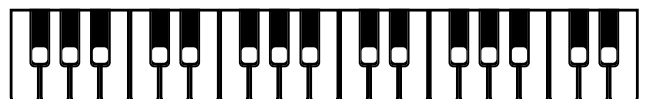

Es Ais C E_b F#



Fis E B_b As C#

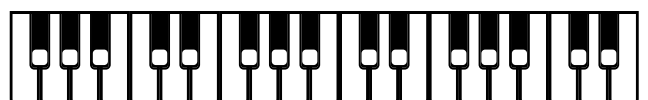

G_b D D# Bes Cis

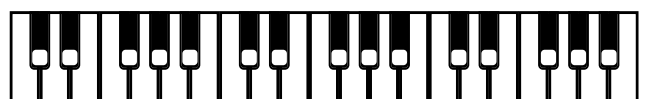

Kopiering til undervisningsbrug må kun ske efter aftale med Copydan Tekst og Node.

SUDOKU 4X4

C#



F#



G#



D#



A#



G#



C#



F#



		F#	

	A#		

SUDOKU 4X4

Gb



Ab



Eb



Bb



Ab



Bb



Db



Eb



Eb			

Db			

Kopiering til undervisningsbrug må kun ske efter aftale med Copydan Tekst og Node.

SUDOKU 4X4

Cis



Fis



Gis



Dis



Ais



Gis

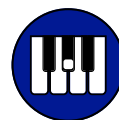

Cis



Fis



Gis			

		Gis	

SUDOKU 4X4

Ges



As



Es



Bes



As



Bes



Des



Es



Es			

		Es	

Kopiering til undervisningsbrug må kun ske efter aftale med Copydan Tekst og Node.

SUDOKU 5X5

C# **D#** **F#** **G#** **A#**

Db **Eb** **Gb** **Ab** **Bb**

C#				

		Db		

SUDOKU 5X5

Cis **Dis** **Fis** **Gis** **Ais**

Des **Es** **Ges** **As** **Bes**

		Cis		

				Des

Kopiering til undervisningsbrug må kun ske efter aftale med Copydan Tekst og Node.

